

SightChek™ Digital Phoropter®

User's Guide



©2020 AMETEK, Inc.

Reichert, Reichert Technologies, Phoroctor, Lensometer, and ClearChart are registered trademarks of Reichert, Inc.

SightChek, AcuityChek, LensChek, and OptoChek are trademarks of Reichert, Inc.

AMETEK is a registered trademark of AMETEK, Inc.

Bluetooth is a registered trademark of Bluetooth SIG.

All other trademarks are property of their respective owners.

The information contained in this document was accurate at time of publication. Specifications subject to change without notice. Reichert, Inc. reserves the right to make changes in the product described in this manual without notice and without incorporating those changes in any products already sold.

ISO 13485 Certified – Reichert products are designed and manufactured under quality processes meeting ISO 13485 requirements.

Refer to IEC 60601-1 for system level information.

No part of this publication may be reproduced, stored in a retrieval system, or transmitted in any form or by any means, electronic, mechanical, recording, or otherwise, without the prior written permission of Reichert, Inc.

Caution: Federal law restricts this device to sale by or on the order of a licensed practitioner. Rx only.

Table of Contents

Symbol Information.....	5
Warnings and Cautions	6
Introduction.....	8
Indications for Use	8
Contra-Indications	8
Instrument Setup	9
Unpacking Instructions.....	9
Parts Identification	10
Setup.....	12
Connecting the SightChek System Components.....	12
Leveling the Phoroceptor Head.....	14
Face Shields	15
Near Vision Rod and Card.....	16
Turn the Unit On and Off.....	16
Connecting Reichert Devices to the SightChek	17
Connecting Reichert Devices with Reichert Wireless Serial Adapters.....	18
Connecting Reichert Digital Acuity Systems to the SightChek.....	20
ClearChart 4 Bluetooth USB	21
Connecting Multiple SightChek External Devices	23
Connecting Multiple SightChek Units.....	23
Control Knob, Screen Icon, and Keypad Button Terminology	25
Control Knob Use	25
Controller Keypad	26
Icon Description	27
Active Data Field.....	27
Auxiliary Lenses or Filters.....	28
Setup Menu.....	31
Screens Available through the Setup Menu.....	31
Measure Data	32
Step	32
Program/Chart Edit.....	33
Editing a Program.....	33
Selecting Default Charts.....	34
Communication.....	35
Instrument 1 and 2.....	35
Projector	35
EMR.....	36
Transfer	36
ID#/Practice	37
Patient ID#.....	37
Practice Name	37
Date/Time	38
Other Settings.....	38
Instructions for Use.....	39
Introduction	39
Aligning the Phoroceptor Head.....	39
Initial Alignment.....	39
Pupillary Distance	40
Corneal Vertex Distance	40
Operator Positioning	40
Data Input.....	41

Table of Contents (continued)

Entering Data Manually	41
Importing Data	42
Adjust Values	43
Adjusting a Refraction From Previously Saved, Transferred, or Input Data	43
Eye Selection	43
Sphere	44
Cylinder	45
Axis	46
Near Vision Addition	47
Cross Cylinder	48
Examination for Astigmatism	49
Patient Responds with Either “1” or “2”	49
Patient Responds with “The Same”	49
Single Target Presentation	50
Axis Adjustment	50
Cylinder Power (JCC) Adjustment	51
Split Cyl Test	52
Axis Adjustment	53
Cylinder Power Adjustment	54
Near Vision Test	55
Fused Cross Cylinder Test	56
Prism Testing	57
Horizontal Phoria Test	58
Vertical Phoria Test	59
Binocular Balance with Prisms	60
Saving Visual Acuity - Distance	61
Right Eye	61
Left Eye	61
Binocular Vision	62
Saving Refraction Data	63
Comparing Refraction Data	64
Data Transfer	65
EMR Output Options	65
Data Output	66
Printing	67
Printer Data Output	68
Clearing All Data	68
Cleaning and Maintenance	69
External Cleaning	69
Controller Screen Cleaning	69
Face Shield Cleaning	69
Forehead Rest Cleaning	69
Fuse Replacement	70
Battery Replacement	70
Shipping the Phoropter Head	70
Troubleshooting	71
Specifications	72
Classifications	74
Guidance Tables	75
Appendix A - Instrument Cables and Bluetooth Kits	79
Warranty	80

Symbol Information

Symbol Information

The following symbols appear on the instrument.



Consult Instructions for Use symbol indicating important operating and maintenance instructions included in this User's Guide



Warning



Type B Product Classification



Protective Earth



Alternating Current Power



ON / OFF



Manufacturer



Date of Manufacture

YYYY-MM-DD

REF

Catalog Number

SN

Serial Number



Waste of Electrical and Electronic Equipment



Compliance to Medical Device Directive 93/42/EEC



Authorized to mark given by Intertek ETL Semko for conformance with electrical standards



Fragile Contents in Shipping Container - handle with care



This Way Up - Indicates correct upright position of package



Keep Dry - Keep package away from rain

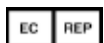

Authorized Representative in European Community

Warnings and Cautions

Warnings and Cautions

Reichert Technologies (Reichert) is not responsible for the safety and reliability of this instrument when unauthorized dealers or persons assemble, disassemble, repair, or modify the instrument, or when a person does not use the instrument in accordance with this User's Guide.

WARNING: AN INSTRUCTION THAT DRAWS ATTENTION TO THE RISK OF INJURY OR DEATH.



WARNING: UNITED STATES FEDERAL LAW AND EUROPEAN REGULATIONS REQUIRE THAT ONLY A LICENSED PRACTITIONER OR A PERSON ACTING ON BEHALF OF A LICENSED PRACTITIONER PURCHASE THIS DEVICE.

WARNING: THE OPERATOR OF THIS INSTRUMENT SHOULD USE IT IN STRICT ACCORDANCE WITH THE INSTRUCTIONS OUTLINED IN THIS USER'S GUIDE. REICHERT TECHNOLOGIES CANNOT GUARANTEE THE SAFETY OF THE OPERATOR AND THE PERFORMANCE OF THE INSTRUMENT IF THE OPERATOR USES THE INSTRUMENT IN A MANNER NOT SPECIFIED BY REICHERT TECHNOLOGIES.

WARNING: DO NOT REPAIR OR SERVICE THIS INSTRUMENT WITHOUT AUTHORIZATION FROM THE MANUFACTURER. EXPERIENCED PERSONNEL OR DEALERS WHO ARE TRAINED BY REICHERT MUST PERFORM ANY REPAIR OR SERVICE TO THIS INSTRUMENT TO PREVENT SERIOUS INJURY TO THE OPERATOR OR PATIENT.

WARNING: NO PERSON IS ALLOWED TO MODIFY THIS INSTRUMENT. REICHERT MUST AUTHORIZE ANY MODIFICATION TO THIS UNIT TO ENSURE CORRECT OPERATION.

WARNING: IF ANY PERSON MODIFIES THIS INSTRUMENT, REICHERT MUST CONDUCT INSPECTION AND TESTING OF THE INSTRUMENT TO ENSURE ITS CONTINUED SAFE USE.

WARNING: CONNECT THIS EQUIPMENT ONLY TO A SUPPLY MAINS WITH PROTECTIVE EARTH TO AVOID THE RISK OF ELECTRIC SHOCK AND TO PREVENT DAMAGE TO THE INSTRUMENT AND/OR INJURY TO THE OPERATOR OR PATIENT.

WARNING: APPLY RATED INPUT VOLTAGE TO THE UNIT AS INDICATED ON THE DATA PLATE TO PREVENT DAMAGE TO THE INSTRUMENT AND/OR INJURY TO THE OPERATOR OR PATIENT.

WARNING: ONLY PLUG THE INSTRUMENT INTO AN OUTLET WITH AN EARTH GROUND. DO NOT REMOVE OR DEFEAT THE INSTRUMENT'S EARTH GROUND CONNECTION ON THE POWER INPUT CONNECTOR OR THE UNIT'S POWER CORD, OR YOU COULD CAUSE DAMAGE TO THE INSTRUMENT AND/OR INJURY TO THE OPERATOR OR PATIENT.

WARNING: DO NOT USE THE EQUIPMENT OR SYSTEM ADJACENT TO OR STACKED WITH OTHER EQUIPMENT. IF YOU NEED TO USE ADJACENT OR STACKED EQUIPMENT, OBSERVE THE EQUIPMENT OR SYSTEM TO VERIFY NORMAL OPERATION IN THE CONFIGURATION IN WHICH YOU USE IT.

WARNING: RISK OF ELECTRIC SHOCK OR FIRE. THIS DEVICE IS NOT INTENDED TO BE USED WITH LIQUIDS. DO NOT PLACE OR USE OPEN LIQUID CONTAINERS NEAR THE DEVICE, DUE TO THE RISK OF SPILLAGE OF LIQUID ONTO THE DEVICE.

WARNING: THIS INSTRUMENT IS NOT SUITABLE FOR USE IN THE PRESENCE OF FLAMMABLE ANESTHETIC MIXTURES, SUCH AS OXYGEN OR NITROUS OXIDE.

WARNING: THE USE OF ACCESSORIES OR CABLES OTHER THAN THOSE SPECIFIED, WITH THE EXCEPTION OF THOSE SOLD BY THE MANUFACTURER AS REPLACEMENT PARTS FOR THE INTERNAL COMPONENTS, MIGHT RESULT IN INCREASED EMISSIONS OR DECREASED IMMUNITY OF THE EQUIPMENT OR SYSTEM.

Warnings and Cautions (continued)

Warnings and Cautions (continued)

WARNING: PRIOR TO INSTALLING THE PHOROPTOR HEAD ONTO THE STAND ARM, VERIFY THAT THE ROD ON THE STAND ARM IS SECURE BEFORE ATTEMPTING TO INSTALL THE PHOROPTOR HEAD OR YOU MIGHT DAMAGE THE UNIT AND/OR INJURE THE PATIENT.

WARNING: OTHER ELECTRICAL OR ELECTRONIC EQUIPMENT CAN INTERFERE WITH THE BLUETOOTH WIRELESS CONNECTION TRANSMITTERS OR RECEIVERS, EVEN IF THAT EQUIPMENT ALSO COMPLIES WITH CISPR EMISSIONS REQUIREMENTS.

CAUTION: AN INSTRUCTION THAT DRAWS ATTENTION TO THE RISK OF DAMAGE TO THE PRODUCT.



CAUTION: THE INTERNAL CIRCUITRY OF THE INSTRUMENT CONTAINS ELECTROSTATIC DISCHARGE SENSITIVE DEVICES (ESDS) THAT ARE SENSITIVE TO STATIC CHARGES PRODUCED BY THE HUMAN BODY. DO NOT REMOVE THE COVERS WITHOUT TAKING PROPER ESDS PRECAUTIONS.

CAUTION: DO NOT USE SOLVENTS OR STRONG CLEANING SOLUTIONS ON ANY PART OF THIS INSTRUMENT TO ENSURE THAT YOU DO NOT DAMAGE THE UNIT. SEE THE MAINTENANCE SECTION OF THIS GUIDE FOR DETAILED CLEANING INSTRUCTIONS.

CAUTION: DO NOT USE AMMONIA-BASED CLEANERS ON THE LIQUID CRYSTAL DISPLAY (LCD) TO ENSURE THAT YOU DO NOT DAMAGE THE DISPLAY. SEE THE MAINTENANCE SECTION OF THIS GUIDE FOR DETAILED CLEANING INSTRUCTIONS.

CAUTION: MEDICAL ELECTRONIC EQUIPMENT REQUIRES SPECIAL PRECAUTIONS REGARDING EMC AND IT NEEDS TO BE INSTALLED AND PUT INTO SERVICE ACCORDING TO THE EMC INFORMATION PROVIDED IN THE ACCOMPANYING DOCUMENTS.

CAUTION: PORTABLE AND MOBILE RF COMMUNICATIONS EQUIPMENT CAN AFFECT MEDICAL ELECTRICAL EQUIPMENT.

CAUTION: DO NOT USE THIS INSTRUMENT NEAR HIGH-FREQUENCY EMITTING SURGICAL EQUIPMENT.

CAUTION: THIS INSTRUMENT IS NOT INTENDED TO BE CONNECTED TO EQUIPMENT OUTSIDE THE CONTROL OF REICHERT TECHNOLOGIES OR IT MUST BE TESTED TO APPLICABLE IEC OR ISO STANDARDS.

CAUTION: DO NOT INSTALL ANY ADDITIONAL SOFTWARE OTHER THAN WHAT IS SUPPLIED WITH THIS INSTRUMENT. IF YOU INSTALL ADDITIONAL SOFTWARE, IT MIGHT CAUSE UNEXPECTED OPERATION, RESULTING IN INSTRUMENT MALFUNCTION.

CAUTION: YOU MUST PLUG THIS INSTRUMENT INTO AN OUTLET WITH AN EARTH GROUND THAT IS CONNECTED TO THE RECEPTACLE TO PREVENT DAMAGE TO THE UNIT. DO NOT DISABLE OR REMOVE THE GROUND PIN.

CAUTION: INGRESS PROTECTION CLASSIFICATION FOR THE INSTRUMENT IS IPX0. DO NOT SPRAY, SPLASH, OR IMMERSE THESE INSTRUMENTS IN CLEANING SOLUTIONS.

Introduction

Introduction

Congratulations on your purchase of the Reichert Technologies® (hereafter referred to as Reichert®) SightChek™ Digital Phoropter®.

This User's Guide is designed as a training and reference manual for operation, maintenance, and troubleshooting. We recommend that you read it carefully prior to use and follow the instructions in the guide to ensure optimum performance of your new instrument. Only properly trained eye care professionals, such as ophthalmologists, optometrists, opticians, and eye care technicians should operate this instrument. All parts of this Medical Electrical system are suitable for use within the patient environment.

Please retain this guide for future reference and to share with other users. For additional copies of this manual or questions related to the SightChek, contact your local authorized Reichert dealer, refer to our website, or contact our Customer Service department directly:

Tel: 716-686-4500

Fax: 716-686-4555

Email: reichert.information@ametek.com

Indications for Use

The SightChek is designed for:

- Subjective measurement of the refractive error of the eye.
- Determination of correction data for refraction anomalies and binocular functions as the basis for manufacturing eyeglasses and contact lenses.
- Measurement of ocular deviation in patients with latent or manifest strabismus.
- Use in refraction rooms in clinics and practices of physicians, optometrists, or opticians.
- Connection to other medical examination equipment or to an office Electronic Medical Records (EMR) system.
- Operation by physicians, optometrists, opticians, or properly trained clinical personnel.
- Installation under the conditions for medical equipment.

Contra-Indications

- There are none associated with the SightChek system.

Instrument Setup

Unpacking Instructions

Great care is taken to deliver your SightChek to you intact. Please read this User's Guide before operating the unit.

We package the instrument in shipping containers to protect the instrument from damage during shipping. Please carefully remove the Phoroceptor Head, Controller, Relay Box Assembly, and Accessories Box from the packaging material.

Note: Please retain the original packaging and use it if future transportation of the instrument is required.

1. Cut the 4 shipping straps and open the outer box by cutting the tape.
2. Remove the top 4 pieces of protective Foam Corners, and remove the inner box. Refer to Figure IS-01.
3. Cut the 4 shipping straps and open the inner box by cutting the tape.
4. Remove the top piece of cardboard.
5. Remove the Reading Rod, Nearpoint Card, Dust Covers and User's Guide from the box. Refer to Figure IS-02.
6. Remove two Accessory Boxes then the two pieces of Protective Cardboard. Refer to Figure IS-03.

First Accessory Box (Refer to Figure IS-04):

- Cable (Phoroceptor Head) (PN 16290-005)

Second Accessory Box (Refer to Figure IS-05):

- Printer Paper (2) (P/N 16290-006)
- 2 Spare Fuses (PN 15170-006)
- Cable (Relay Box Assembly)(PN 16290-005)
- USB Bluetooth Adaptor (PN 13779)

7. Remove the Controller from the box and set aside. Refer to Figure IS-03.
8. Remove the Power Cords and remove them from their bubble wrap envelope.

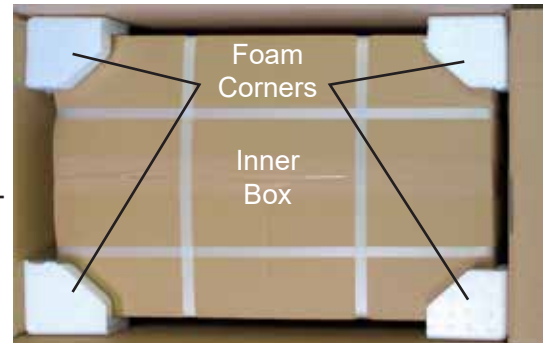

Figure IS-01 Top Foam Layer

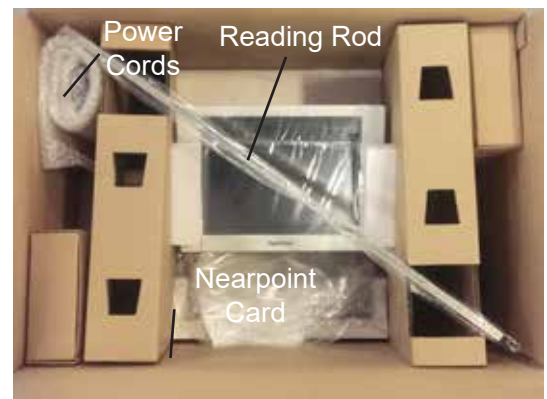

Figure IS-02 Controller & Accessories

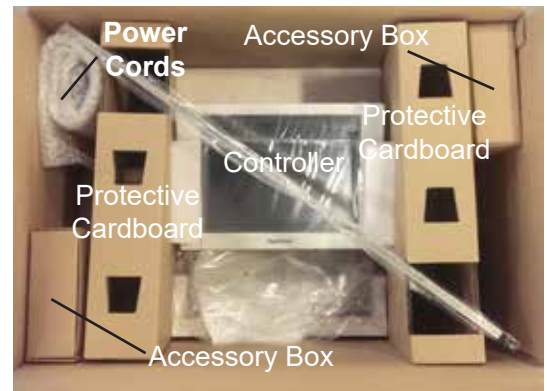

Figure IS-03 Packaging - Phoroceptor Head



Figure IS-04 First Accessory Box

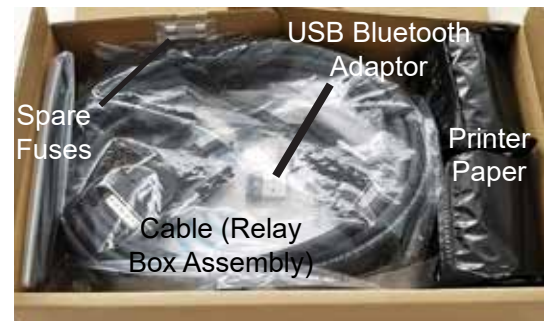

Figure IS-05 Second Accessory Box

Instrument Setup (continued)

Unpacking Instructions (continued)

9. Remove the lower piece of protective cardboard.
10. Remove the Phoroceptor Head (wrapped in plastic bubble). Refer to Figure IS-06.
11. Remove the plastic wrapping from the Phoroceptor Head, carefully placing the Phoroceptor Head aside with the patient side down.
12. Remove the Relay Box Assembly.

Note: If any of the above accessories or parts are missing, immediately contact Reichert, so we can ship the missing accessories or parts.



Figure IS-06 Phoroceptor and Relay Box Assembly

Parts Identification

All following parts of the SightChek Digital Phoroceptor are in the shipping container:

Description	Part Number
SightChek Digital Phoroceptor (REF 16290)	
Includes	
• SightChek Head Assembly	16291
• SightChek Relay Box Assembly	16293
• SightChek Controller	16292
Accessories	
• Dust Cover – Phoroceptor Head	16290-007
• Dust Cover – Controller	16292-007
• Cable (Phoroceptor Head)	16290-005
• Cable (Controller)	16290-005
• User’s Guide	16290-101
• Near Vision Card and Holder	16290-008
• Power Cord 120V or	16290-003
Power Cord 230V	16290-004
• Near Vision Card Rod	16290-002
• Face Shield Kit	16290-851
• Thermal Paper	16290-006
• Fuses	15170-005
• Bluetooth Antennae`	RANT10001
• USB Bluetooth Adaptor	13779

Optional Accessories

The following optional accessories are available for use with the SightChek System:

Description	Part Number
• Decimal Near Vision Kit	16290-012
• Snellen Near Vision Kit	16290-008
• Cables & Bluetooth Dongles for connecting Reichert equipment	Appendix A

Instrument Setup (continued)

Parts Identification (continued)

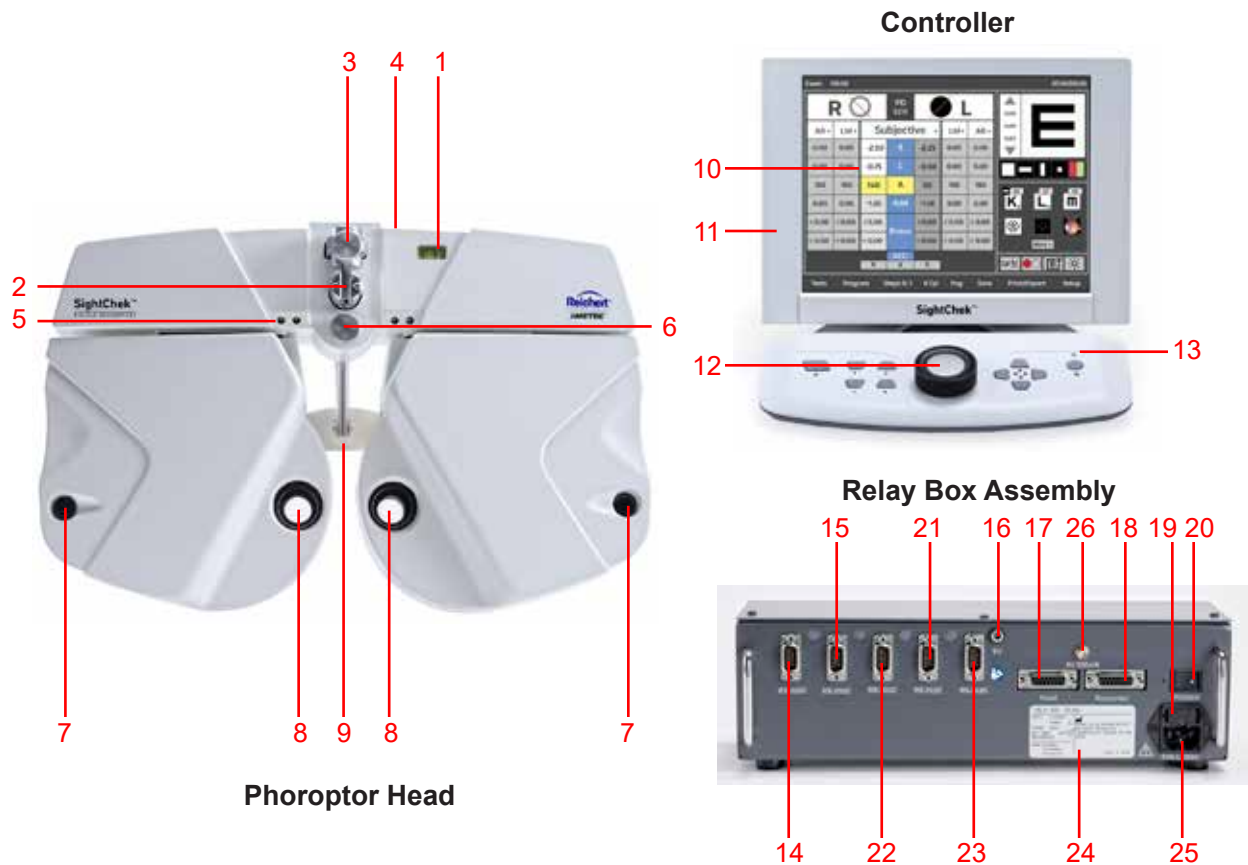

Figure IS-07 Parts Identification

- | | |
|--|-------------------------------|
| 1. Level | 14. Inst 1 Port |
| 2. Near Vision Rod Holder | 15. Inst 2 Port |
| 3. Near Vision Rod Securing Knob | 16. 5V Power Source |
| 4. Leveling Knob
(on top, visible from above) | 17. SightChek Head Port |
| 5. Card Illumination Source | 18. SightChek Controller Port |
| 6. Headrest Adjustment Knob | 19. Fuse Holder |
| 7. Vertex Distance Window | 20. Power Switch |
| 8. Apertures | 21. Proj Port |
| 9. Headrest | 22. EMR Port |
| 10. LCD Touch Screen | 23. Transfer Port |
| 11. Printer (on back) | 24. Data Plate |
| 12. Controller Knob | 25. Power Inlet |
| 13. Power Indication Light | 26. Bluetooth Antenna Port |

Setup

Connecting the SightChek System Components

WARNING: APPLY RATED INPUT VOLTAGE TO THE UNIT AS INDICATED ON THE DATA PLATE TO PREVENT DAMAGE TO THE INSTRUMENT AND/OR INJURY TO THE OPERATOR OR PATIENT.

WARNING: CAREFULLY ARRANGE THE CABLES FOR THE UNIT AND ACCESSORIES, SO THE CABLES DO NOT PRESENT A TRIPPING HAZARD TO THE OPERATOR OR A DANGER TO THE PATIENT.

WARNING: POSITION THIS INSTRUMENT SO THE PLUG IS EASILY ACCESSIBLE.

WARNING: DO NOT PLUG IN THE UNIT UNTIL THE COMPUTER SYSTEM IS SETUP.

1. Connect the Cable (Phoroceptor Head) (PN 16290-005) to the Phoroceptor Head by aligning the cable to the Pins in the Phoroceptor Head and securely attaching the Cable. Refer to Figure IS-08.
2. Secure the two screws on the Cable (Phoroceptor Head) by turning them clockwise, until the cord is fully secured and properly seated to the top of the Phoroceptor Head. Refer to Figure IS-09.
3. Connect the Phoroceptor head to the Relay Box Assembly by attaching the Cable (Phoroceptor Head) (PN 16290-005) to the Phoroceptor port on the Relay Box Assembly. Secure it with the two screws by turning them clockwise.
4. Connect the Controller to the Relay Box Assembly by attaching the Cable (Controller) (PN 16290-005) to the Controller port in the Relay Box.
5. Connect the Projector to the Relay Box by attaching a cable (PN 16200-440) or pairing a Bluetooth adapter to the projector port in the Relay Box Assembly.
6. Connect a computer to the Relay Box by attaching a serial cable to the EMR port in the Relay Box.
7. Connect Reichert Lensometers or Auto Refractors to the Relay Box by attaching the cable or pairing a Bluetooth adapter to the Instrument 1 or Instrument 2 port in the Relay Box, as needed.

Note: The instrument includes connection cables for the Phoroceptor Head and the Controller. You must purchase separately all connection cables or Bluetooth adapters for connecting Lensometers, Auto Refractors, projectors, and computers.

8. Plug in the power cord to an outlet providing appropriate voltage.
9. Connect the SightChek to another SightChek through the Transfer port to send data from one device to another. You can make the connection using the appropriate serial cable or Bluetooth.

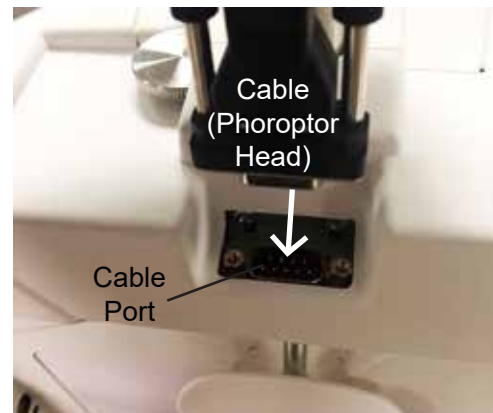

Figure IS-08 Phoroceptor Head Cable



Figure IS-09 Cable Installed

Instrument Setup (continued)

Setup (continued)

Connecting the SightChek System Components (continued)

Please refer to the Connection Diagram in Figure IS-10 for plug and cable layout.

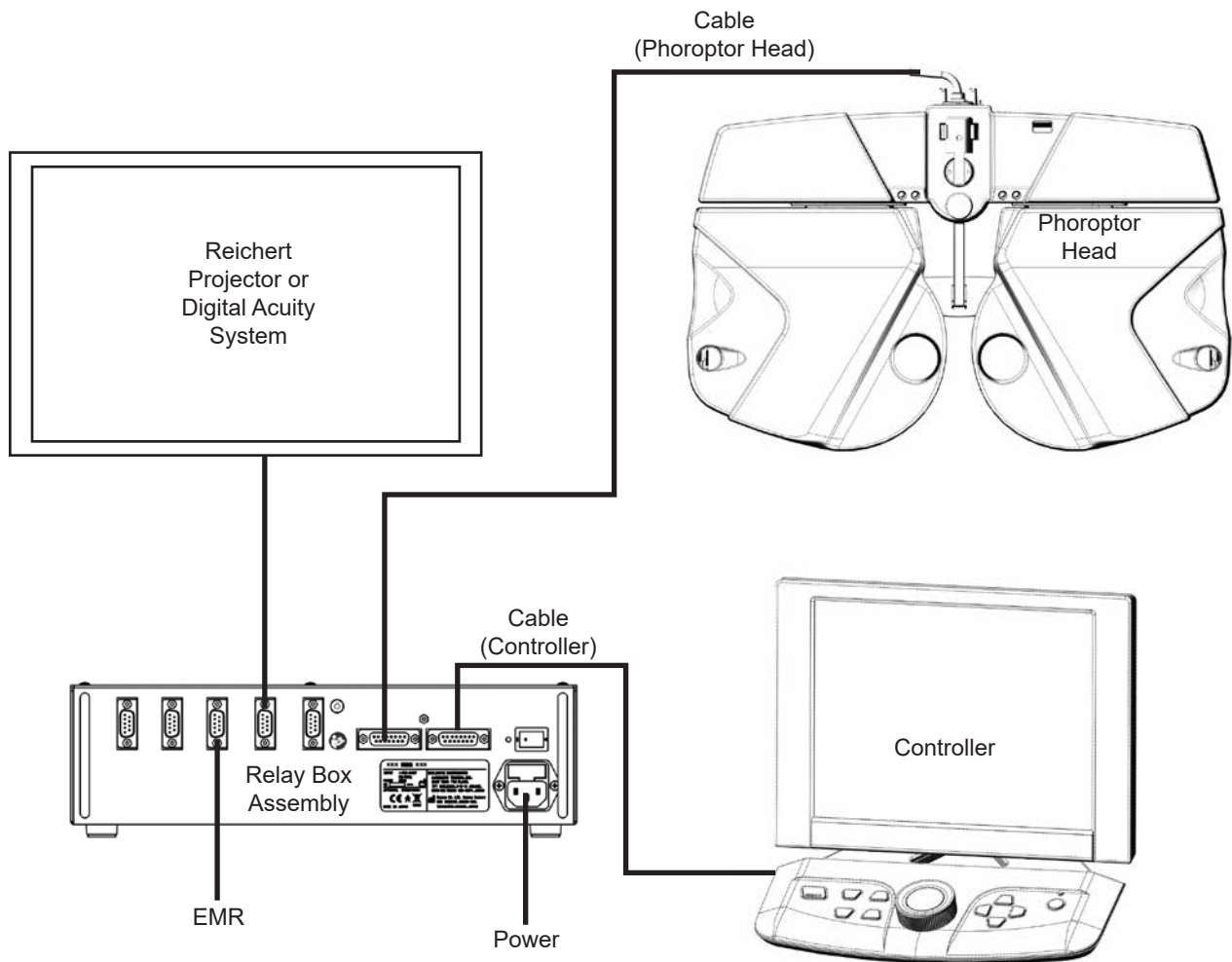

Figure IS-10 Connection Diagram

Instrument Setup (continued)

Setup (continued)

Leveling the Phoroceptor Head

After you install the Phoroceptor Head onto the stand and connect all the cables, check to see if the Phoroceptor Head requires leveling. If the Phoroceptor Head is not level, adjust it by rotating the Thumb Screw on the top of the Phoroceptor Head.

1. Check the bubble inside the Level on the Phoroceptor Head. Refer to Figure IS-11.



Figure IS-11 Level

2. Turn the Leveling Knob slowly clockwise or counterclockwise to adjust the level of the Phoroceptor Head. Refer to Figure IS-12.



Figure IS-12 Leveling Knob

3. Continue leveling the Phoroceptor Head, until the bubble in the Level looks like the “Level” picture at the right side of Figure IS-11.

Instrument Setup (continued)

Setup (continued)

Face Shields

A set of face shields are provided for the patient side of the SightChek Phoropter Head to help keep the equipment clean. Magnets hold the face shields in place, enabling the user to easily remove, clean, and replace the shields. Refer to Figures IS-13.



Figure IS-13 Install Face Shield

Instrument Setup (continued)

Setup (continued)

Near Vision Rod and Card

The near vision testing accessories include a rod and reading card. Slide the card onto the near vision rod and position it at the desired reading distance. Loosen the thumb screw on the convergence lever in the center of the Phoropter head. Mount the near vision rod in the convergence lever and tighten the thumb screw. The Reading Rod Holder is held in the stored position by a retaining clip. The Rod Hinge contains a plastic holder, securing the rod into the clip when moved to the vertical position. Refer to Figure IS-14.

Note: Please exercise caution when moving the Phoropter head to make sure the rod is not inadvertently lowered.

Note: The Card Illumination Source automatically illuminates when the Add box is selected on the SightChek Controller.

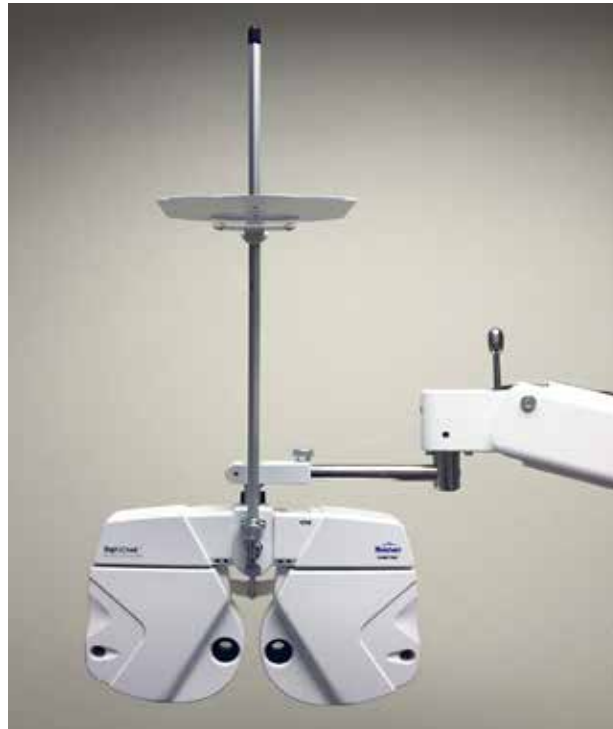

Figure IS-14 Near Vision Rod & Card Holder

Turn the Unit On and Off

The ON/OFF switch for the SightChek is located on the Relay Box Assembly. The entire system (Phoropter Head and Controller), is connected to the Relay Box Assembly and turned ON/OFF from this location.

The initialization time of the computer in the SightChek is approximately 50 seconds. When the Phoropter Head is turned ON, it automatically returns all lenses to zero power and sets the pupillary distance to 64mm (default setting). To shut down the system, set the ON/OFF switch to OFF.

Instrument Setup (continued)

Connecting Reichert Devices to the SightChek

The basic system setup contains three items programmed to interact with each other: the Phoroptor Head, the Relay Box Assembly, and the Controller. The Relay Box Assembly directs communication between the Phoroptor Head, Controller, and other external devices, while the Controller acts as the user interface and controls the Phoroptor Head and the Input/Output of data.

The SightChek is also designed to communicate with Reichert Digital Acuity Systems, Auto Lensometers and Auto Refractors. Computers are connected using serial cables or Bluetooth wireless serial adapters.

Note: Ensure that the device with which you are interfacing is compatible with the SightChek. Refer to Appendix A for a list of devices that connect to the SightChek, and for the necessary connection cables or Bluetooth dongle kits to communicate with the SightChek.

The following instructions describe how to connect external devices to the SightChek Relay Box Assembly using Bluetooth wireless serial adapters.

Connecting Reichert Devices with Reichert Wireless Serial Adapters

Reichert designed a proprietary Bluetooth serial adapter to connect Reichert devices to the SightChek. In order to establish wireless communications between the SightChek and an external device, you must first configure the Reichert Bluetooth dongle for a specific Relay Box port (e.g., Projector, EMR, Inst1, Inst2, Transfer) and program the adapter with the serial communications parameters (baud rate, data bits, parity, stop bits) required by the external device.

Perform these steps to configure a Bluetooth dongle for communication with an external device using a specific Relay Box port:

1. Turn on the SightChek.
2. Touch **SETUP** on the Controller screen, located at the bottom right of the screen.
3. Touch **COMMUNICATION** on the Settings screen.
4. Select the specific port to configure.
5. Select the device from the drop-down menu and select the wireless check box. Refer to Figure IS-15.

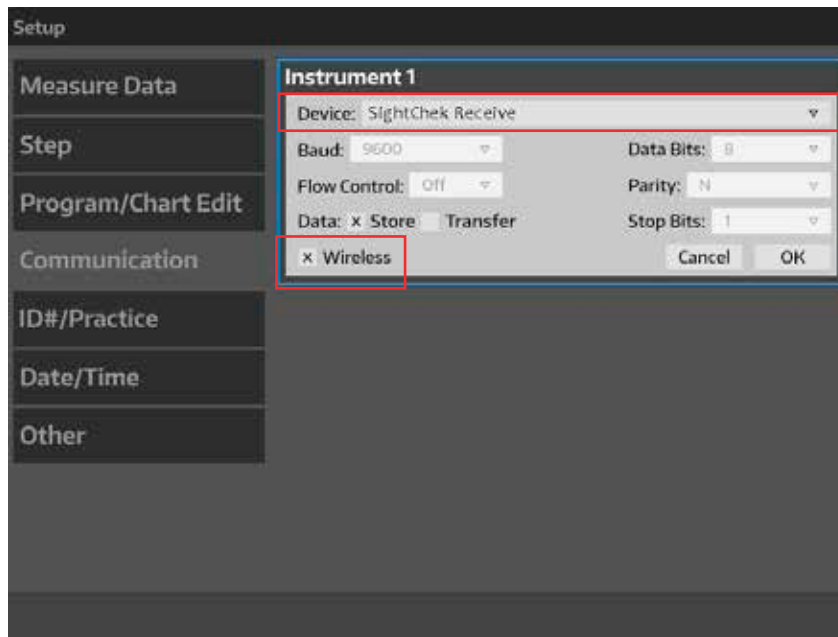

Figure IS-15 Instrument1 Setting Screen

-continued-

Connecting Reichert Devices with Reichert Wireless Serial Adapters (continued)

6. Plug the Bluetooth dongle into a power outlet, using the power adapter provided.
7. Gently press and hold the Bluetooth dongle's reset switch, using an appropriate object (paperclip), until the LED illuminates red.

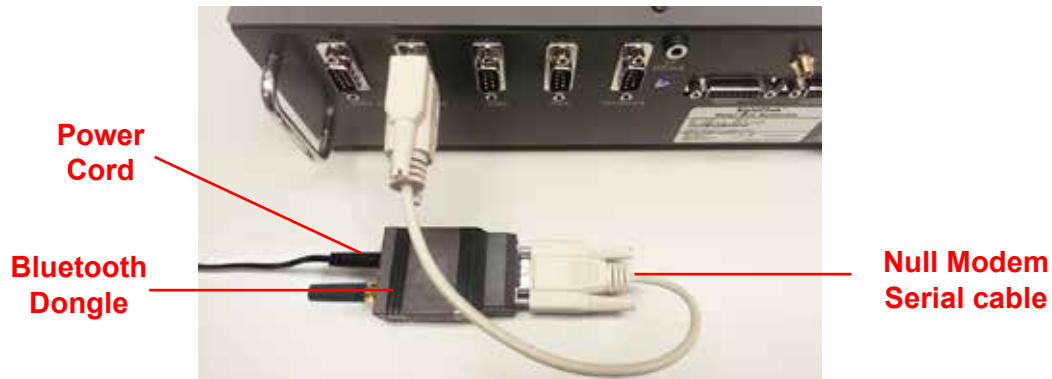

Figure IS-16 Bluetooth Dongle to Relay Box Assembly

Note: The reset switch is accessed via the small hole located on the side of the Bluetooth dongle.

8. Connect the Bluetooth dongle to the appropriate Relay Box port, using the provided null modem serial cable. Refer to Figure IS-16.

Note: The Relay Box port must correspond to the connected external device. (For example, if you use the Bluetooth dongle to connect a refractor/keratometer to the SightChek, use one of the two Instrument ports. Likewise, if you use the Bluetooth dongle with a visual acuity system, use the Relay Box Assembly's Projector port.)

9. Tap the **OK** button and wait several seconds to make sure that the driver is loaded. Refer to Figure IS-16.
10. The LED indicator on the Bluetooth dongle will first illuminate red, when not paired. When pairing is in process, the LED will illuminate blue. Once the connection has been established, the LED indicator will remain green.
11. Disconnect the Bluetooth dongle from the Relay Box.
12. Connect the Bluetooth dongle to the external device's serial port, using the required adapter or cable, and connect the power adaptor.
13. The LED indicator on the Bluetooth dongle will first illuminate red. Once the connection has been established again, the LED indicator will remain green.
14. If the configuration fails:
 - a. Verify that the Bluetooth dongle was connected to the correct Relay Box port.
 - b. Ensure that a null modem cable was used to connect the Bluetooth dongle to the Relay Box, according to the cables specified in **Appendix A**.
 - c. Repeat Steps 7-9 of this process.

Note: At this point the Relay Box and/or the Bluetooth dongle may be powered off and on in any order. The wireless connection will be established automatically every time once both devices are powered on as long as the wireless check box on the COMMUNICATION page is not touched.

CAUTION: DO NOT TOUCH THE OK BOX AGAIN. IF THE OK BOX IS TAPPED ACCIDENTALLY, IT WILL BE NECESSARY TO REPEAT THE ABOVE PROCEDURE TO REESTABLISH THE WIRELESS CONNECTION.

Connecting Reichert Digital Acuity Systems to the SightChek

Wired communication between the ClearChart 2, ClearChart 4, ClearChart 4X, AcuityChek, ClearChart 3P or ClearChart 4P and the SightChek requires connection of a cable specified in **Appendix A**. The cable connects to the serial port on the digital acuity system and the Projector port on the Relay Box.

Wireless communication between the ClearChart 2, ClearChart 4, ClearChart 4X, AcuityChek, ClearChart 3P or ClearChart 4P and the SightChek requires connection of the Bluetooth serial adapter to the serial port on the lower back of the digital acuity system, powered by the USB connection on the side of the device or with a separate AC adapter. Refer to Figures IS-17 and IS-18.



Figure IS-17 ClearChart Bluetooth Cables



Figure IS-18 Bluetooth Adaptor

The SightChek Relay Box communicates through built-in Bluetooth using the antenna at the back of the unit. Refer to Figure IS-19. (Please refer to the instructions in the previous section, **Connecting Reichert Equipment with Reichert Wireless Serial Adapters**, to connect devices to the SightChek using Bluetooth dongle serial adapters.)

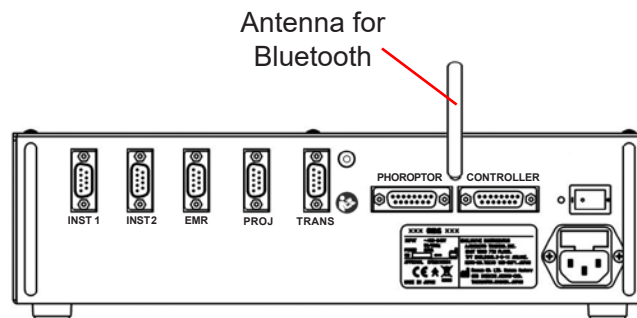

Figure IS-19 Antenna for Bluetooth - Relay Box

Instrument Setup (continued)

ClearChart 4 Bluetooth USB

Reichert has a Bluetooth USB option to connect an AcuityChek, ClearChart 4, 4X or 4P to the SightChek. In order to establish wireless communications between the SightChek and the acuity system, you must first pair the Projector port to the Bluetooth USB adapter:

1. Turn on the SightChek.
2. Touch **SETUP** on the Controller screen, located on the bottom right of the screen. Refer to Figure IS-20.

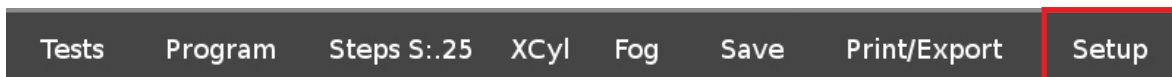

Figure IS-20 Setup

3. Touch **COMMUNICATION** on the Settings screen.
4. In **COMMUNICATION**, select Projector.
5. On the Projector panel, select the acuity system from the drop-down menu. Refer to Figure IS-21.

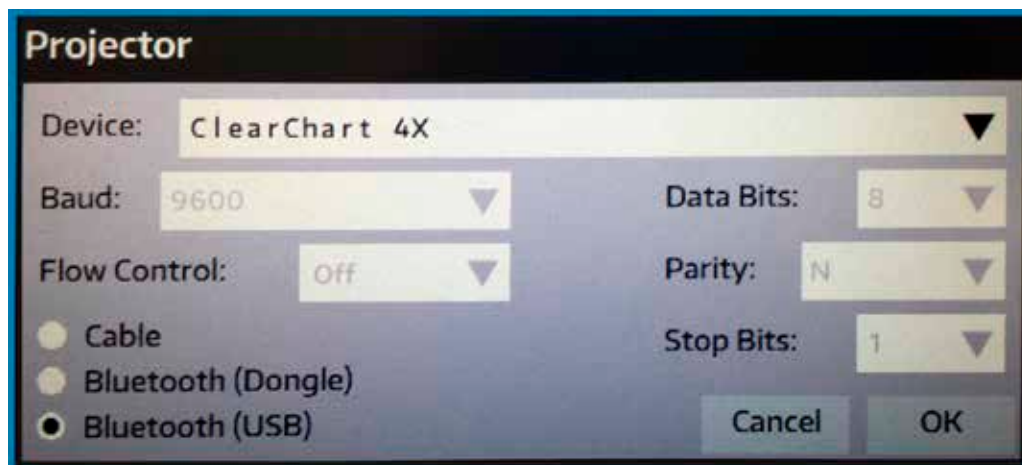

Figure IS-21 Projector

Note: The Bluetooth USB is only compatible with the AcuityChek, ClearChart 4, 4X or 4P.

6. Set the Connection Type to Bluetooth (USB).

Instrument Setup (continued)

ClearChart 4 Bluetooth USB (continued)

7. Install the Bluetooth USB into the ClearChart. Then power ON the ClearChart. Refer to Figure IS-22.

Note: The Bluetooth USB must be installed in the Clearchart before the ClearChart is powered ON or the Bluetooth USB will not be paired properly.



Figure IS-22 Bluetooth Installed

8. Press the Menu button on the ClearChart remote and view the Bluetooth address in the lower right corner of the ClearChart. Refer to Figure IS-23.



Figure IS-23 Bluetooth Address

9. On the SightChek Communication page press the OK button and then it will search for the bluetooth device.
10. Once the Bluetooth address is displayed, select the address that matches the address on the ClearChart and click "OK." Refer to Figure IS-24.
11. If unsuccessful pairing the SightChek to the ClearChart, check all the connections and repeat the steps in this section.



Figure IS-24 Bluetooth Address

Connecting Multiple SightChek External Devices

1. Connect Reichert Lensometers and Reichert Auto Refractors to either of the instrument ports on the Relay Box using a serial cable designated for use with the external device. Refer to Appendix A for a list of different Reichert devices that communicate with the SightChek and the specifications of serial cables used to connect these devices.

Note: Auxiliary external devices can also communicate wirelessly with the SightChek. Refer to the instructions in the Connecting Reichert Equipment with Reichert Wireless Serial Adapters section to connect auxiliary external devices to the SightChek using Bluetooth serial adapters. Refer to Appendix A for a list of Bluetooth dongle kits required to connect specific external devices.

Note: Configure the Instrument ports to communicate with specific external devices. Refer to the instructions in the Options/Set-up Menu section to configure the settings.

Connecting Multiple SightChek Units

Multiple SightChek units can be setup to communicate with each other as a means of transferring data from one set of pre-test equipment (Auto Refractor and Lensometer) to multiple exam rooms. Refer to Figure IS-25.

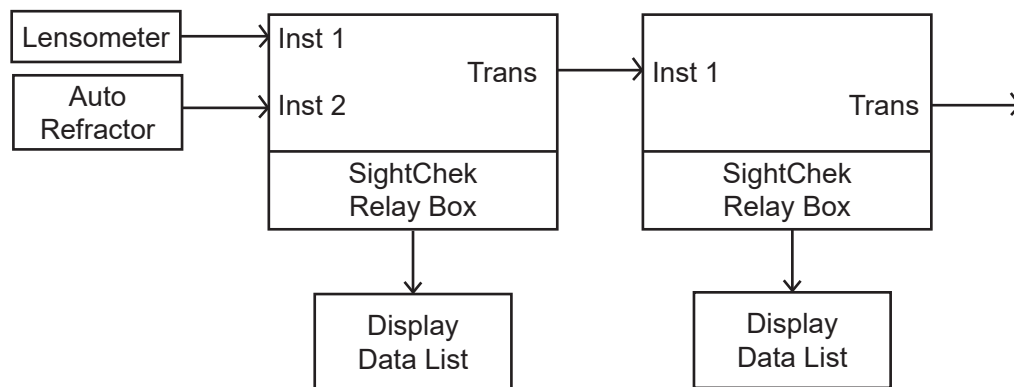

Figure IS-25 Connecting Multiple Units

Connecting Multiple SightChek External Devices (continued)

Connecting Multiple SightChek Units (continued)

1. Setup the Auto Refractor and Lensometer to communicate with the SightChek closest to that location, using wired or wireless connections to the Inst1 and Inst2 ports.
2. Connect the Relay Box of the first SightChek to the Relay Box of the SightChek next in line, using a cable or Bluetooth dongle connection, according to the cables specified in **Appendix A**. The Transfer port on the first SightChek is the data output port, and the Inst1 port on the next SightChek receives the data. Refer to Figure IS-26.
3. Repeat step 2 until you connect all exam rooms with SightChek systems. There is no limit to the number of SightChek units you can link together.
4. Locate the Transfer section of the Communication screen and set the parameters. Refer to Figure IS-27.

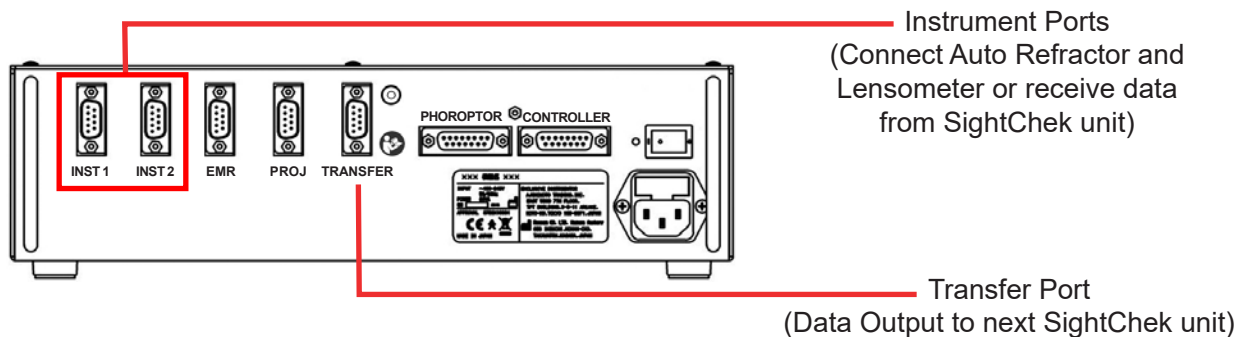

Figure IS-26 Multiple SightChek Systems Set-Up

5. Locate the Instrument 1 section of the Communication screen and set the parameters as per Figure IS-28.

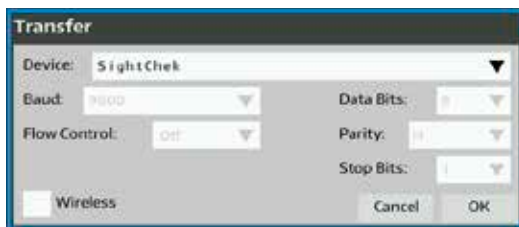

Figure IS-27 Transfer Setting for Sending Data from the previous SightChek

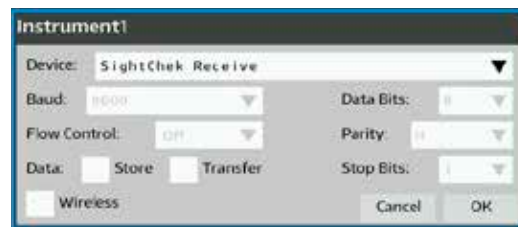

Figure IS-28 Instrument1 Setting for Receiving Data from the previous SightChek

Instrument Setup (continued)

Control Knob, Screen Icon, and Keypad Button Terminology

The SightChek performs all common refraction methods. The user selects the order of the examination steps. Activate the functions using the SightChek Controller Keypad buttons, the Control Knob, or the Controller Touchscreen.

Control Knob Use

Rotate the control knob clockwise or counterclockwise to change the numeric values and the selection of fields as follows:

- Clockwise rotation (rotating the control knob to the right) increases the plus (+) Sphere power, plus (+) Cylinder power, or increases the power of prism in a certain direction.
- Counterclockwise rotation (rotating the control knob to the left) increases the minus (-) Sphere power, minus (-) Cylinder power, or increases the power of prism in a certain direction.

Press the Control Knob to do the following:

- Move to the next Refraction step.
- Finish the operation.

Note: To adjust a specific measurement, touch the data field on the screen and rotate the control knob to adjust the value (e.g., sphere in the right eye).

From this point forward, when the guide refers to the Control Knob, Screen Icons, or Keypad Buttons, the instructions state:

CONTROL KNOB

- “Press the **CONTROL KNOB**”
- “Rotate the **CONTROL KNOB**”

SCREEN ICON

- “Touch **XXXX**...”

KEYPAD BUTTON

- “Press the **XXXX** button.”

CONTROL KNOB AND TOUCH SCREEN ICON CHOICE

- “Press the **CONTROL KNOB**, or touch **XXXX**...”

Controller Keypad

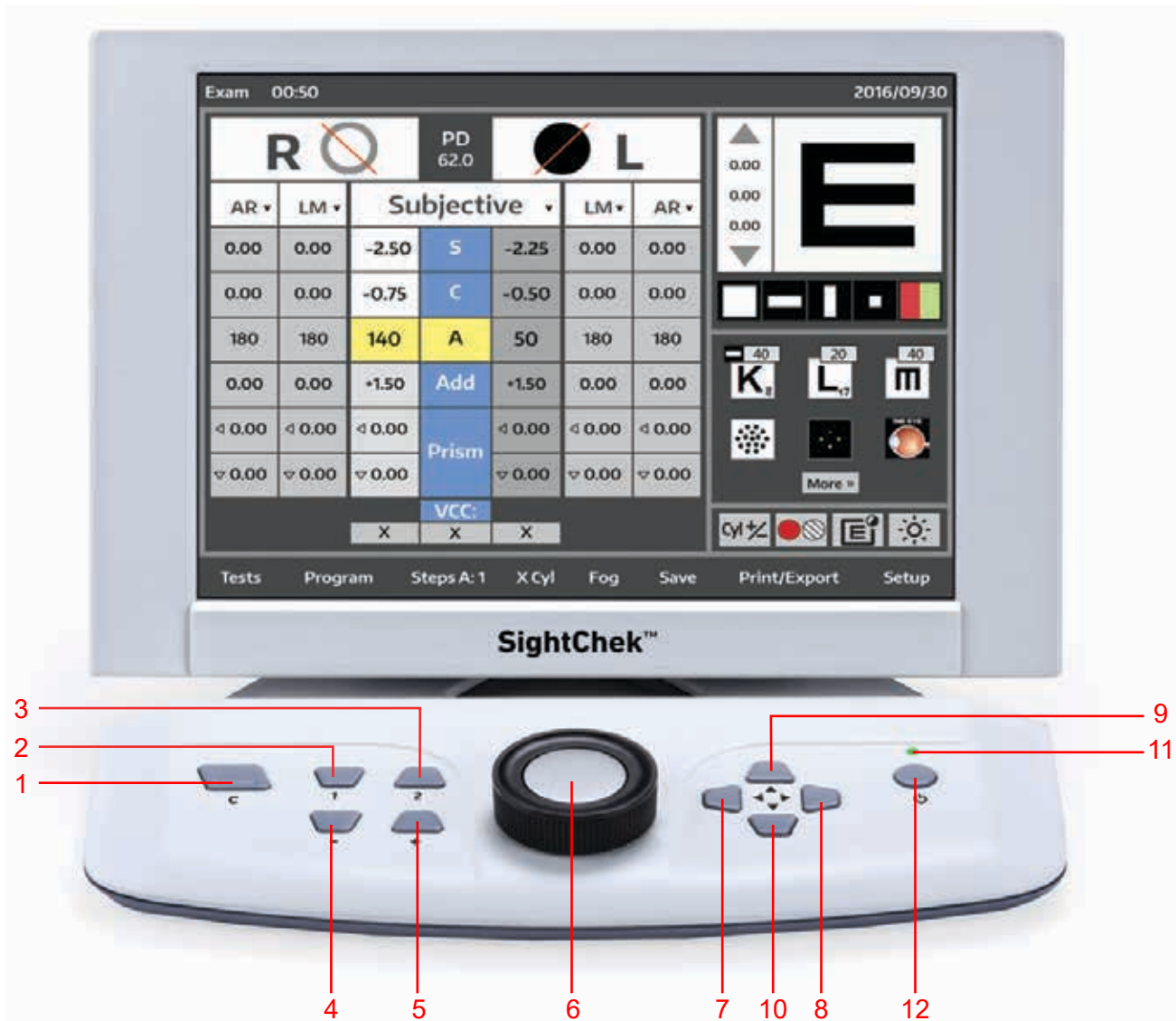

Figure IS-29 Controller Keypad

- 1. Clear Button
- 2. 1 Button
- 3. 2 Button
- 4. - Button
- 5. + Button
- 6. Controller Knob (Dual Action)
- 7. Selection Key LEFT
- 8. Selection Key RIGHT
- 9. Selection Key UP
- 10. Selection key DOWN
- 11. Power Indicator
- 12. Power Saving Button

Instrument Setup (continued)

Icon Description

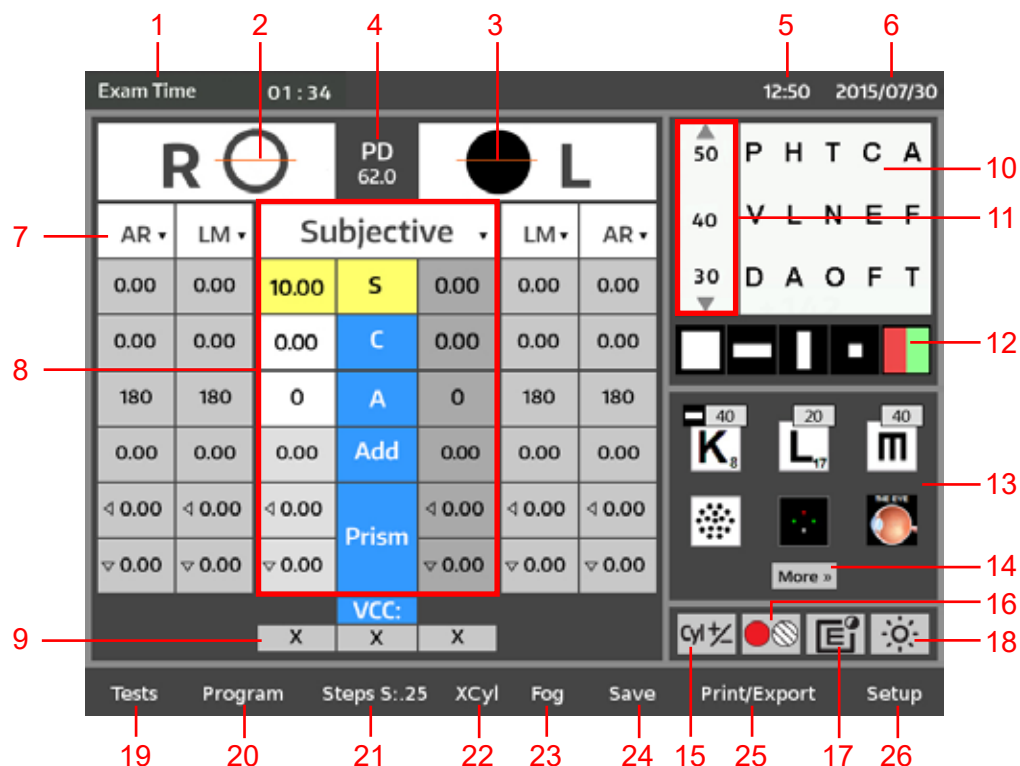

Figure IS-30 Display Screen

- | | |
|---|---|
| 1. Exam Time | 13. Preselected Acuity Test Charts |
| 2. Right Eye Aperture Details | 14. Access to All Charts in the Digital Acuity System |
| 3. Left Eye Aperture Details | 15. Switches from + to - cylinder mode |
| 4. Pupillary Distance | 16. Auxiliary Tests Lenses |
| 5. Current Time | 17. Turns the Digital Acuity System On/Off |
| 6. Current Date | 18. Screen Brightness Adjustment |
| 7. Lensometer & Auto Refractor Data (Entered manually or electronically.) | 19. Special Tests Menu |
| 8. Subjective Data (Appears when data from saved/input data is changed.) | 20. User Created Programs |
| 9. VSC (Changes to VCC when lens data is present) | 21. Steps |
| 10. Projected Chart View/Patient Chart View | 22. XCyl Menu |
| 11. Optotype Size | 23. Fog |
| 12. Acuity Chart Masks | 24. Saves Current Data To Additional Memory Locations |
| | 25. Print and/or Exports current data |
| | 26. Setup Menu |

Active Data Field

The larger box with data is the current/active prescription that is being adjusted. The individual measurement boxes are one of three colors. The following indicates the meaning of each color:

- White** - Active field that can be adjusted.
- Yellow** - Active field that is currently being adjusted.
- Grey** - Inactive field that is not currently being adjusted.

Instrument Setup (continued)

Icon Description (continued)

Auxiliary Lenses or Filters

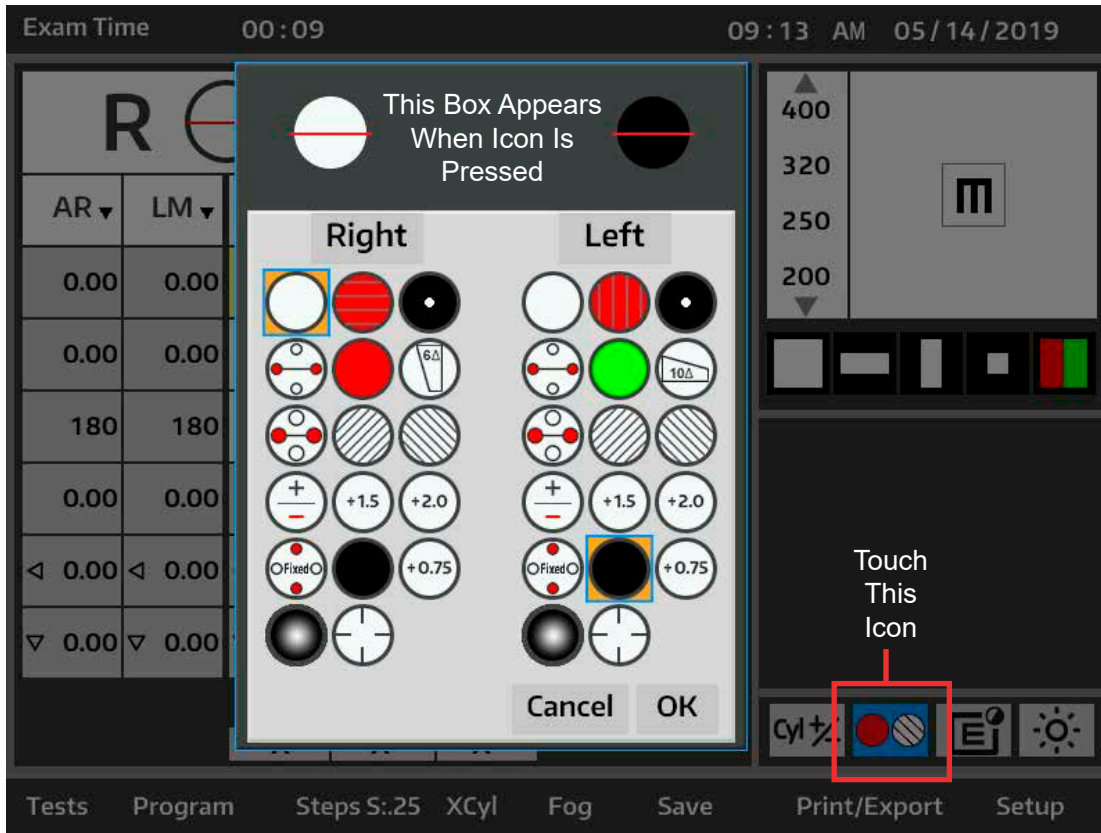

Figure IS-31 Auxiliary Lenses Screen

1. Touch **RED/POLARIZED Lens Icon**, located on the bottom of the screen, just below the chart, to access the auxiliary lenses and filters. Refer to Figure IS-31.

Note: The lenses and filters appear in a pop-up box. Refer to Figure IS-31.

Note: The circles adjacent to the R and L above the Active Data Field indicate which filters are in place in the Phoropter Head apertures.

Note: The following is an example of the R/L indication on the Controller monitor for the Red/Green filter with the red filter in the right eye and the green filter in the left eye:



2. Press **OK**, located at the bottom of the pop up screen, to apply the desired filters to the lens apertures. Refer to Figure IS-31.

Instrument Setup (continued)

Icon Description (continued)

Auxiliary Lenses or Filters (continued)

The following explains the Auxiliary Lens icons:



Open Occluder

Touch to open the aperture of the right or left eye.



Red Maddox Rod

Touch to place a horizontal or vertical Maddox cylinder in the left or right eye.



Pinhole Mask

Touch to place a pinhole mask in the left or right eye.



0.25D XCyl

Touch to place XCyl lenses in the left or right eye.

Note: XCyl lenses are automatically placed during XCyl testing and selecting the corresponding dioptric power. In this mode, pressing the control knob at the end of the test removes the XCyl cylinder lenses.

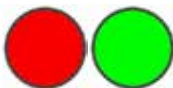

Red/Green Filters

Touch to place a red filter in the right eye and a green filter in the left eye.

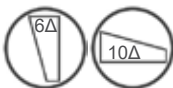

Dissociation Prisms

Touch to place a 6 ▼ base up prism in the right eye. Touch to place 10 ► base in in the left eye.



0.50D XCyl

Touch to place XCyl lenses in the left or right eye.

Note: XCyl lenses are automatically placed during XCyl testing and selecting the corresponding dioptric power. In this mode, pressing the control knob at the end of the test removes the XCyl cylinder lenses.

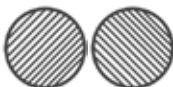

Linear Polarization Filters

Touch to place a linear polarization filter in the left or right eye.



Split Cylinder

Touch to place split cylinder lenses in the left or right eye.

Note: Split cylinders are automatically placed during XCyl testing and selecting split cyl from the XCyl menu. In this mode, pressing the control knob at the end of the test removes the split cylinder lenses.

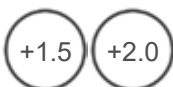

Retinoscopy Lens

Touch to place retinoscopy lenses in the right or left eye. The lens powers available are +1.5 D or +2.0 D. Touch **OPEN APERTURE** to remove the retinoscopy lenses.

Instrument Setup (continued)

Icon Description (continued)

Auxiliary Lenses or Filters (continued)



Fixed Cross Cylinders

Touch to place fixed cross cylinders in the left or right eye.

Note: Fixed Cross Cylinders do not have a screen icon. They automatically switch in when measuring PD. They also switch in when measuring Fused Cross Cylinder addition at near. The icon appears on the Controller in the Active Lenses/Filters, displayed in the graphic above.



Close Occluder

Touch to close the aperture in the left or right eye.



Fog Lenses

Touch to place 0.75D fog in the right or left eye.

Note: Fogging can be achieved by touching the Fog icon at the bottom of the screen. The amount of fog is user defined in the setup menu.



Circular Polarization Filters

Touch to place circular polarization filters in the left and right eye.



Cross Hair Lens

Touch to place a cross hair lens in the right or left eye.

Instrument Setup (continued)

Setup Menu

The Setup Menu is only accessible from the Main screen. The following is a summary of the Setup Menu and all of the corresponding drop-down lists that coincide with each category in the Setup Menu.

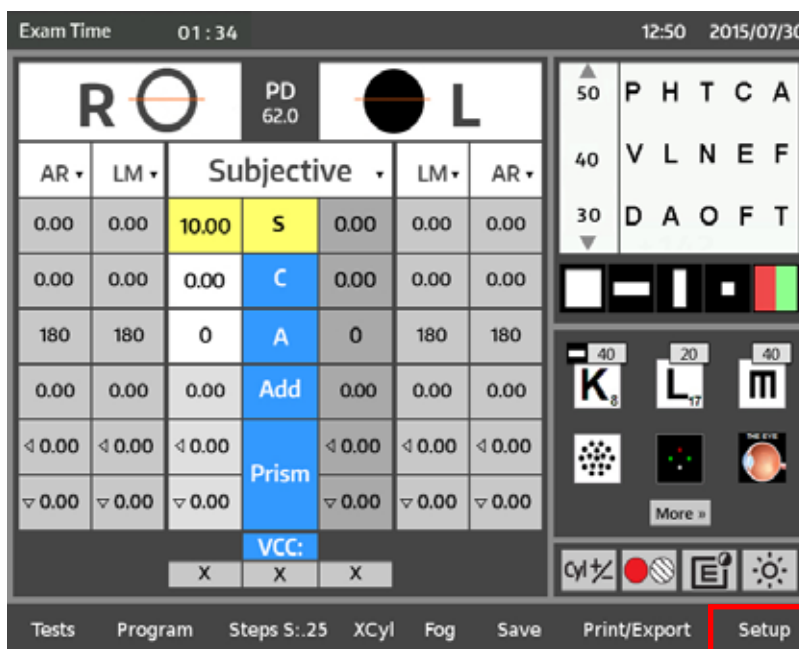

Figure IS-32 Setup

1. Touch **SETUP** in the bottom right corner of the screen to access the Setup screen. Refer to Figure IS-32.
2. Touch the gray box of the setting you want to change, revealing a list of options on the right.
3. Touch the option in the list you want to change.
4. Repeat Steps 1-3 for each setting you want to change.
5. Touch **EXIT** in the bottom right corner of the screen when finished to save your selections and exit the Settings Menu.
6. Touch **YES** to Save changes or **NO** to discard changes

Note: You can enter multiple settings before touching **EXIT**.

Screens Available through the Setup Menu

The following screens are available by touching their screen icons at the bottom of the Options screen:

- **Measure Data:** Enables you to specify default settings, increments, units, display units and fogging amounts.
- **Step:** Enables you to select the amount of change for each turn of the control knob.
- **Program/Chart Edit:** Enables you to record step sequences in a program file that is played from the Main screen, and to select the exam charts to display on the digital acuity system.
- **Communication:** Enables you to set up ports to connect with external devices.
- **ID#/Practice:** Enables you to enter a practice name or patient ID number to appear on printouts.
- **Date/Time:** Enables you to change the date and time, and the format it is displayed.
- **Other:** Enables you to select the default language, output setting, screen brightness, confirmation tone, test sequence, default aperture, and displays the software revision.

Instrument Setup (continued)

Setup Menu (continued)

Measure Data

This section allows the user to select the default parameters for various parts of the system. Refer to Figure IS-33.

C Sign: Set the cylinder to +, - or +/-.

P Format: Set to display the prism in either Cartesian (X/Y coordinates (Base In, Base Out, Base Up, Base Down)) or Polar (Polar coordinates in degrees).

S Display: Set to Far Point or Near Point.

VA Format: Set to have the charts in either 1.0, 20/20 or 6/6 formats.

Note: This selection only applies if no digital acuity chart is connected. If a digital acuity chart is connected, the chart setting will override this selection.

VD: Set the vertex distance to 12, 13.75, 16 or 18mm.

XC Power: Set the cross cylinder power to 0.25, 0.50, or auto.

WD: Set the working distance to 12, 16, 20, 24, or 28 inches when WD unit is set to inches. 30,40,50,60 or 70 cm when WD is set to CM. 3.3, 2.5, 2.0, 1.7 or 1.4 diopters when WD is set to Diopter.

WD Unit: Set to cm, inch or diopter.

Fog: Set to +0.50D, +0.75D, +1.5D or +2.0D.

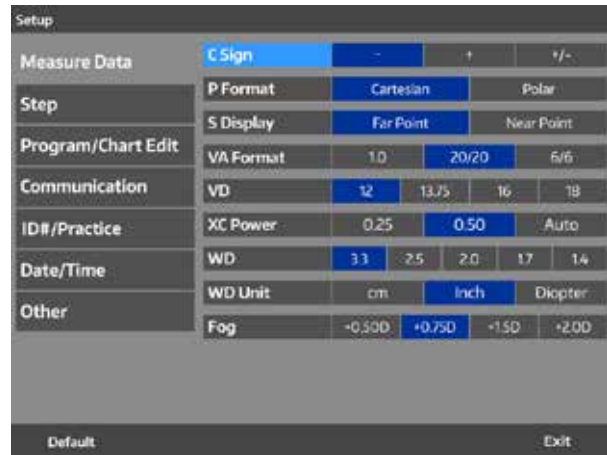

Figure IS-33 Measure Data

Step

This section allows the user to select the default steps for different parts of the examination process. Refer to Figure IS-34.

S Step: Set the sphere value to change in either 0.12, 0.25, 0.5 or 1.0D steps.

C Step: Set the cylinder value to change in either 0.25 or 0.5 steps.

A Step: Set the axis value to change in either 1°, 5° or 10° steps.

P Step: Set the prism value to change in either 0.1, 0.5 or 1 steps.

Theta Step: Set the prism axis value to change in either 1° or 5° steps.

PD Step: Set the pupillary distance to change in either 0.5 or 1 mm steps.

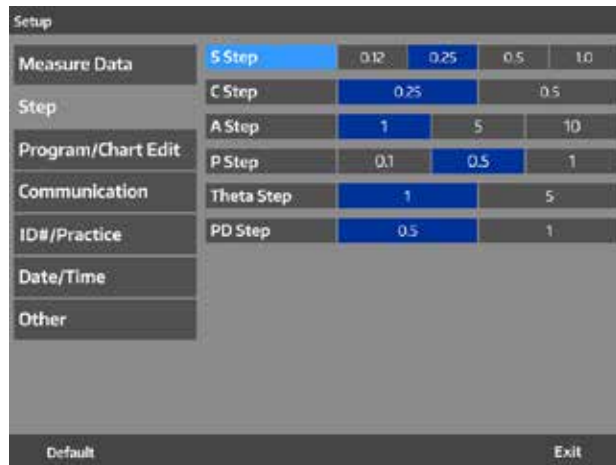

Figure IS-34 Step

Instrument Setup (continued)

Setup Menu (continued)

Program/Chart Edit

Up to 3 different programs can be created or edited and used when performing a refraction with the SightChek. Default charts can also be pre-set in this setting as well. Refer to Figure IS-35.

Editing a Program

1. Touch **EDIT** next to the Program you wish to edit. The Programs screen will appear. Refer to Figure IS-35.

Note: Be sure that the Program being edited or created is highlighted/selected at the top of the box, under Program Selection. Refer to Figure IS-36.

2. Touch the mode and eye for each step desired, and touch **INSERT** on the bottom to add it to the program sequence.
3. The steps will appear in order on the right side, under Program Listing.
4. To add or change items in the list, touch the step, then touch either Clear, Insert, Modify, Delete etc to change or delete or move the selected step.

Note: Specific charts can be displayed for each examination step in a program. To select a specific chart, touch the CHART box in the lower middle section of the screen. Refer to the **Selecting Default Charts** section of this manual.

5. To save the changes, touch **EXIT**. A pop up will appear prompting to save.
6. Touch **YES** to save or **NO** to discard changes.

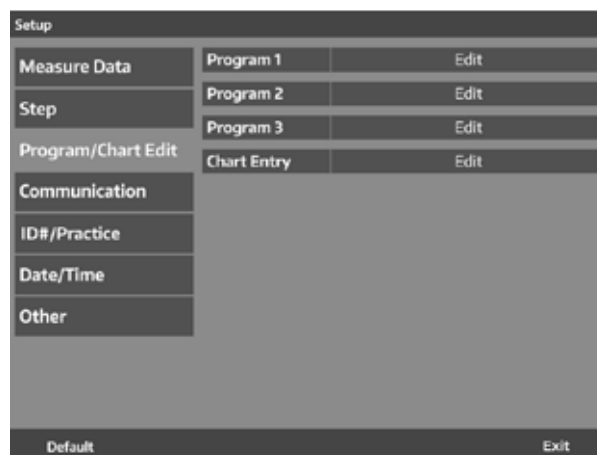

Figure IS-35 Program/Chart Edit

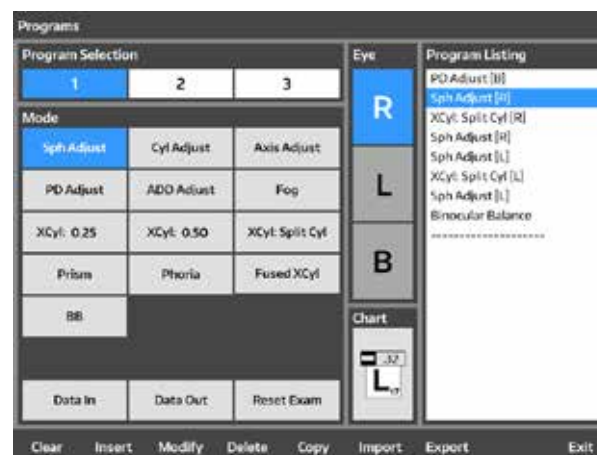

Figure IS-36 Edit Program

Instrument Setup (continued)

Setup Menu (continued)

Program/Chart Edit (continued)

Selecting Default Charts

The Default Chart allows the user to select a specific chart that is displayed after clearing the instrument or previous values and beginning the examination procedure. Default charts can also be selected for specific examination procedures. When performing those specific tests, a selected default chart will appear.

1. Touch either **CHART** in the edit program section, or **Chart Entry** on the Program/Chart Edit tab. Refer to Figure IS-35 and IS-36
2. The Charts screen will pop up. Refer to Figure IS-37.
3. Touch the desired chart.

Note: There are multiple screens of charts. Touch the right arrow icon at the end of the row of charts to access the second set of charts. Touch the back arrow to return to the previous charts.

4. Touch the “+” and “-” buttons under the VISUS section to change the size of the optotypes to be displayed.
5. Touch the desired mask to select a default mask for the chart.
6. Touch either **DEFAULT** to select the modified chart that will appear when beginning an examination, or touch the corresponding test the chart will appear for.

Note: Default charts can be selected for Prism, X Cylinder, Phoria, and Binocular Balance (BB) tests.

7. Touch **MODIFY**. The icon for the selected chart will now appear in the thumbnail.
8. To save the changes, touch **EXIT**. A pop up will appear prompting to save.
9. Touch **YES** to save or **NO** to discard changes.

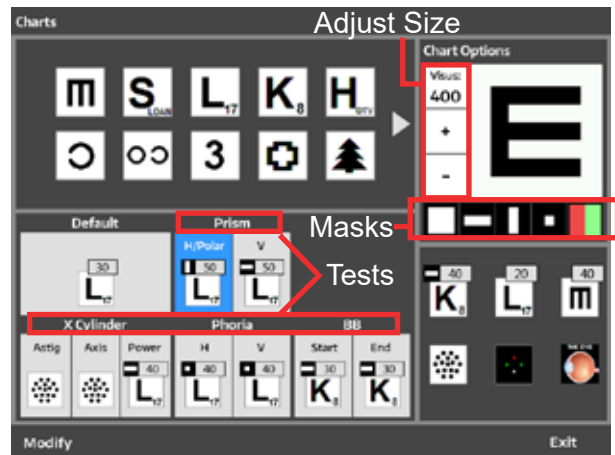

Figure IS-37 Program/Chart Edit

Instrument Setup (continued)

Setup Menu (continued)

Communication

This section allows the setup of auxiliary equipment, acuity systems, and the sending and receiving of data to and from an EMR system to be configured for the SightChek. Lensometer and Autorefractor data can be setup to import pre-test data and have the information automatically populate the fields at the beginning of a refraction.

Instrument 1 and 2

Select up to 2 auxiliary pieces of equipment to connect with the SightChek and import data.

1. Touch either **INSTRUMENT1** or **INSTRUMENT2** to add or edit auxiliary equipment connection settings. Refer to Figure IS-38.
2. Select the instrument from the drop down Device tab. Refer to Figure IS-39.
3. Select if this data is being Stored or Transferred, and select the appropriate box(es). Refer to Figure IS-40.
4. If this is being connected wirelessly, check the Wireless box. Refer to the Wireless Dongle Kit instructions for further information on setting up wireless communication. Refer to Figure IS-40.
5. Touch **OK** to save the settings and close the Instrument1 settings box, and go back to the Communication screen. Refer to Figure IS-40.

Projector

The ClearChart 2, ClearChart 3P, ClearChart 4, ClearChart 4X, Clearchart 4P and AcuityChek can all be directly interfaced with the SightChek.

1. Touch **PROJECTOR** on the Communication menu. Refer to Figure IS-38.
2. Select the Device that is being connected.
3. If this is being connected wirelessly, check the Wireless box. Refer to the Wireless Dongle Kit instructions for further information on setting up wireless communication.
4. Touch **OK** to save the settings and close the Instrument1 settings box, and go back to the Communication screen.

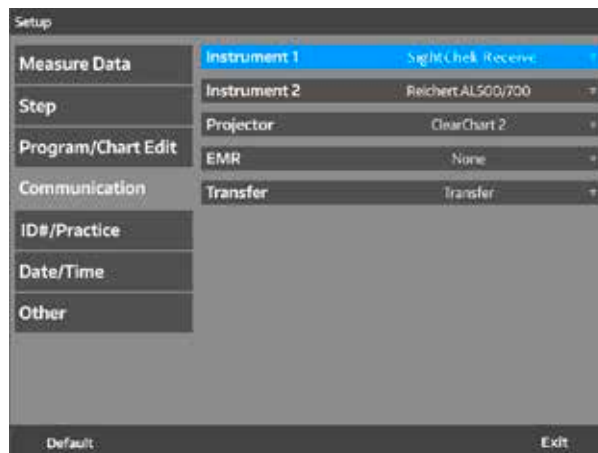

Figure IS-38 Settings Menu

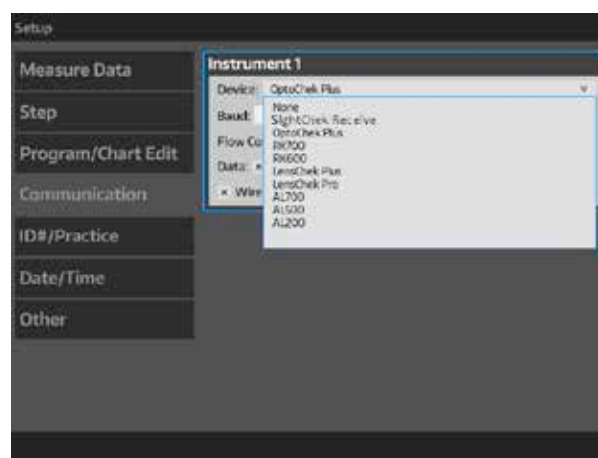

Figure IS-39 Settings Menu

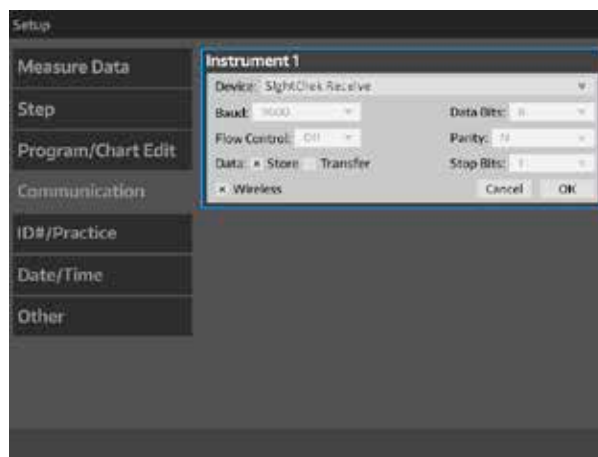

Figure IS-40 Settings Menu

Instrument Setup (continued)

Setup Menu (continued)

Communication (continued)

EMR

To setup an EMR system that data transfers to/from, touch **EMR** on the Communication menu.

1. Touch **EMR** to edit the connection settings. Refer to Figure IS-41.
2. Select the device protocol that is being connected to the SightChek from the drop down menu. Refer to Figure IS-42.
3. The appropriate Baud Rate, Flow Control, Data Bits, Parity and Stop Bits will appear.
4. If this is being connected wirelessly, check the Wireless box. Refer to the Wireless Dongle Kit instructions for further information on setting up wireless communication.
5. Touch **OK** to save the settings and close the EMR settings box, and go back to the Communication screen. Refer to Figure IS-43.

Transfer

1. Select the device that is being connected to the SightChek from the drop down menu that is transferring the data. Refer to Figure IS-41.
2. If this is being connected wirelessly, check the Wireless box. Refer to the Wireless Dongle Kit instructions for further information on setting up wireless communication.
3. Touch **OK** to save the settings and close the EMR settings box, and go back to the Communication screen.

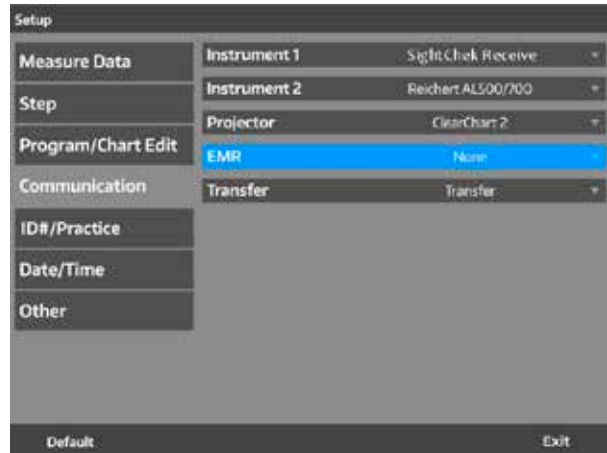

Figure IS-41 Settings Menu

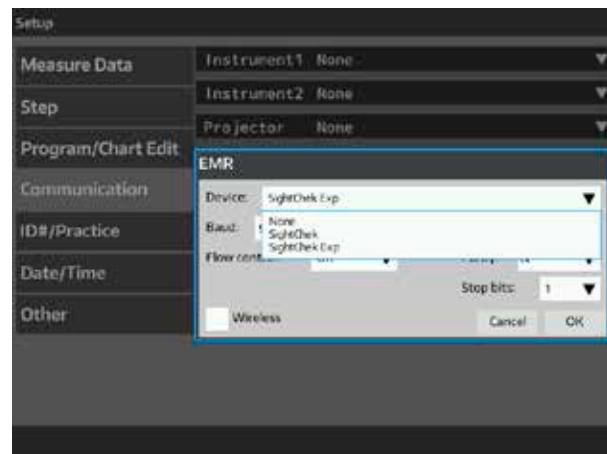

Figure IS-42 Settings Menu

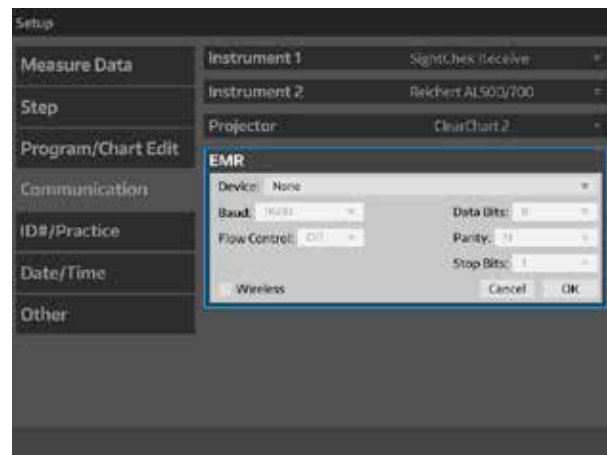

Figure IS-43 Settings Menu

Instrument Setup (continued)

Setup Menu (continued)

ID#/Practice

The SightChek can print out the practice name and/or ID number for the patient. Use this setting to add or edit the practice name as it appears on the printout.

Patient ID#

Every time the SightChek is turned off and on, the Patient ID# will reset. Use this box to change the default Patient ID#. Refer to Figure IS-44.

1. Touch the digit to be changed, or press the right or left arrow to select the digit to be changed. Set the ID by touching the “-” button, pressing the “+” button, or rotating the control knob.
2. Touch **EXIT** to save the selection and exit the Setup menu. The ID# will be displayed at the time of data output and/or printing.

Practice Name

A practice name can be entered or edited with this field. The practice name will appear on printouts.

1. Touch **PRACTICE** to enter the text editing screen. Refer to Figure IS-44.
2. Touch each character to create the practice name. Refer to Figure IS-45.

Note: Up to 22 characters can be used.

3. To delete a single character, highlight the character to the right. Touch the delete icon (the left facing arrow with the X in it, on the far right).
4. To delete the entire entry and start again, touch **CLEAR**.
5. Touch **EXIT** to save the practice name and a pop up will appear.
6. Touch YES to Save or NO to discard the changes, and go back to the Setup menu.

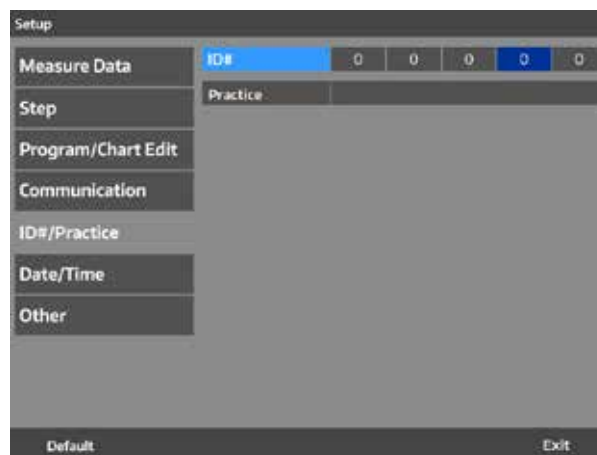

Figure IS-44 Settings Menu



Figure IS-45 Settings Menu

-continued-

Instrument Setup (continued)

Setup Menu (continued)

Date/Time

Touch the preferred setting for each of the items below to modify that setting. Refer to Figure IS-46.

Date Display: Set to YES to display the date on the screen, or NO to hide the date.

Date Format: Select how the date will appear on the screen and printouts. Choose from either MDY, DMY, or YMD.

Time Format: Select the time to be displayed in either 12 hour format (AM/PM) or 24 hr format.

Date: Set the current date by touching the field (month, day or year, depending on the Date Format selected) and use the “-” and “+” buttons to change the selection.

Time: Set the current time by touching the field (hours, minutes and AM or PM, depending on the Time Format selected) and use the “-” and “+” buttons to change the selection.

Other Settings

The Other tab has all of the other settings that can be selected and made. Refer to Figure IS-47.

Language: Select the language. The options are English, French, German, Spanish, Portuguese, Italian and Chinese.

Output: Select whether the data will be printed, transferred to an EMR system (PC), or both.

Brightness: Set the brightness of the screen. Options are 10%, 50% or 100%.

Tone: Set whether or not an audible tone will sound when buttons or screen selections are made.

Aperture Default: Select the default position of the apertures when starting a refraction. Options are Right Open, Left Open or Both Open.

Ref. Sequence: Select the preferred refraction step sequence. Options are SCA (sphere, cylinder, axis), SAC (sphere, axis, cylinder), SCAS (sphere, cylinder, axis, sphere) or SACS (sphere, axis, cylinder, sphere). Pressing the **CONTROL KNOB** advances through the selected sequence of refraction steps after each step is completed.

Binocular Only: Set whether or not both apertures will be open during the refraction.

Software Version: The software version is listed at the bottom right of the screen.

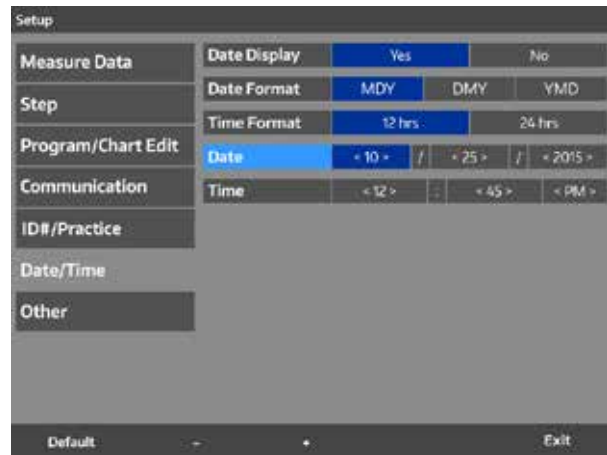

Figure IS-46 Date/Time

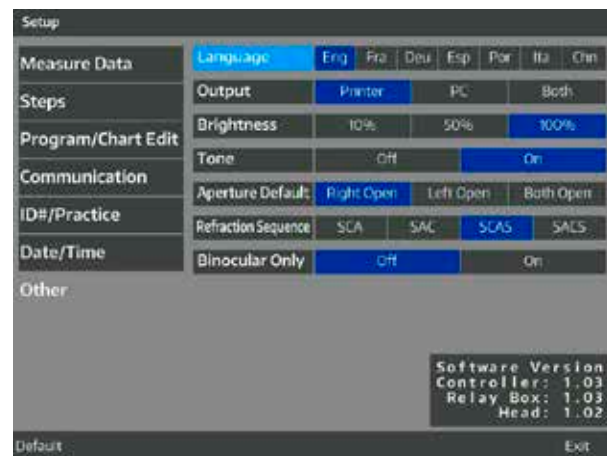

Figure IS-47 Other

Instructions for Use

Introduction

Align the Phoroceptor Head with the patient to ensure you are taking reliable measurements. Once the Phoroceptor Head is powered on and completes an initialization process, you can then align it and take measurements.

Aligning the Phoroceptor Head

Initial Alignment

The first alignment is the general alignment of the Phoroceptor Head to the patient.

1. Place the back side of the Phoroceptor Head in front of the patient, centering the head in front of the patient's eyes. (Please refer to Figures IU-01 and IU-02.)

Note: The Forehead Rest is an applied part that makes contact with the patient.

2. Position the patient's head against the forehead rest.
3. Use the Level on the Phoroceptor Head to ensure the Phoroceptor Head is level. Refer to Figure IU-03.

Note: If the Phoroceptor Head is not level, refer to the **Setup - Leveling the Phoroceptor Head** section of this manual.

4. It may be necessary to adjust the Phoroceptor head to align with the patient's anatomical variation or head tilt. Be sure the eyes are centered in the apertures by adjusting the head alignment and PD.

Note: If the Phoroceptor head accidentally converges while positioning it in front of the patient, press the **CLEAR** button twice to re-home the head.

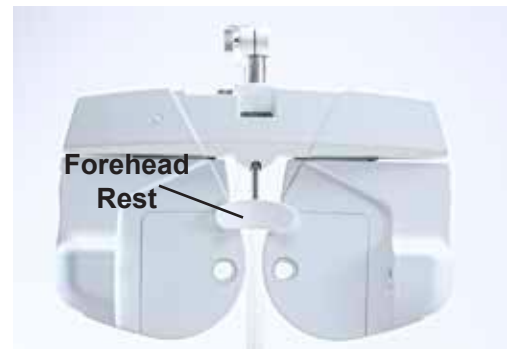

Figure IU-01 Back Side of Phoroceptor Head



Figure IU-02 Adjust Phoroceptor Head



Figure IU-03 Level

Instructions for Use (continued)

Aligning the Phoropter Head (continued)

Pupillary Distance

The next adjustment is the Pupillary Distance (PD). Using the Control Knob on the Controller, adjust the pupillary distance between the right and left apertures on the Phoropter Head.

Note: If the Auto Refractor or Lensometer data transmits PD measurements when the data is brought in as a starting point for the refraction, the Phoropter Head automatically moves to adjust to that PD.

Perform the following steps to adjust the PD:

1. Touch PD at the top of the screen. Both apertures display cross hair lenses.

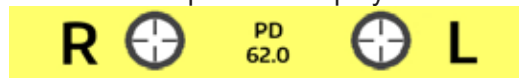

2. Use the crosses in the lenses to center the patient's pupil in each aperture.

Note: The illumination for the Vertex Distance Window lights up to help with alignment.

3. Rotate the **CONTROL KNOB** to the right to increase the pupil distance and to the left to decrease pupil distance. Increments may be set to 0.5mm or 1mm in the Setup Menu.

Corneal Vertex Distance

The next adjustment is the Corneal Vertex Distance to ensure that the Phoropter Head's lenses are at the proper distance from the patient's eyes.

Note: The default vertex distance is 13.75 mm. This is indicated by the longer black hash mark. Refer to Figure IU-04.

Perform the following steps to measure the Corneal Vertex Distance:

Look into the Corneal Vertex Distance Windows and line up the corneas by turning the forehead rest knob, so the target line and the target mark superimpose. Refer to Figure IU-04.



Figure IU-04 Vertex Distance Window

Operator Positioning

The operator positions himself or herself for the examination once the Phoropter Head is in place in front of the patient. The operator can sit or stand, and should be in a position to easily access the Controller. The instrument is operated the same way whether the operator is sitting or standing, or positioned on the left or right side of the patient.

Instructions for Use (continued)

Data Input

Once the Phoroptor Head is aligned, measurements can now be taken. Pretest measurements can be imported as a starting point for a refraction.

The SightChek allows you to electronically receive data from Reichert external devices, such as Auto Lensometers and Auto Refractors. Electronically entering data into the SightChek is possible using one of the following options. Connections are made using either a serial cable or Bluetooth adapter.

- **Manually** - AR and LM values can be manually entered with the Controller.
- **Direct Connection** - The Reichert devices send data directly to the SightChek. The AR and LM data fields are automatically populated when the user presses the data output buttons on each external device.
- **Stored Data List** - The external device data is automatically sent directly to the SightChek stored Data List. The AR and LM data fields are automatically populated when the user selects the patient information from the pop up window.
- **Through EMR** - If the EMR system interfacing with the SightChek supports two-way communication, the external devices send data directly to the EMR system, then the EMR system sends the data to the SightChek. The AR and LM data fields are automatically populated when sent from the external device.

Entering Data Manually

Perform the following steps to enter data manually. Refer to Figure IU-05.

1. Touch the drop-down arrow next to **AR** or **LM**.
2. Touch **SET** in the pop up window.
3. Touch **S** to enter the sphere value, **C** for cylinder, **A** for axis, **Add** for add and **BI/BO**, **BU/BD** for prism values and touch **OK**.

Note: The **C** on the number pad is to clear the data, the **±** will change the sign.

4. Touch **OK** to complete the selection.

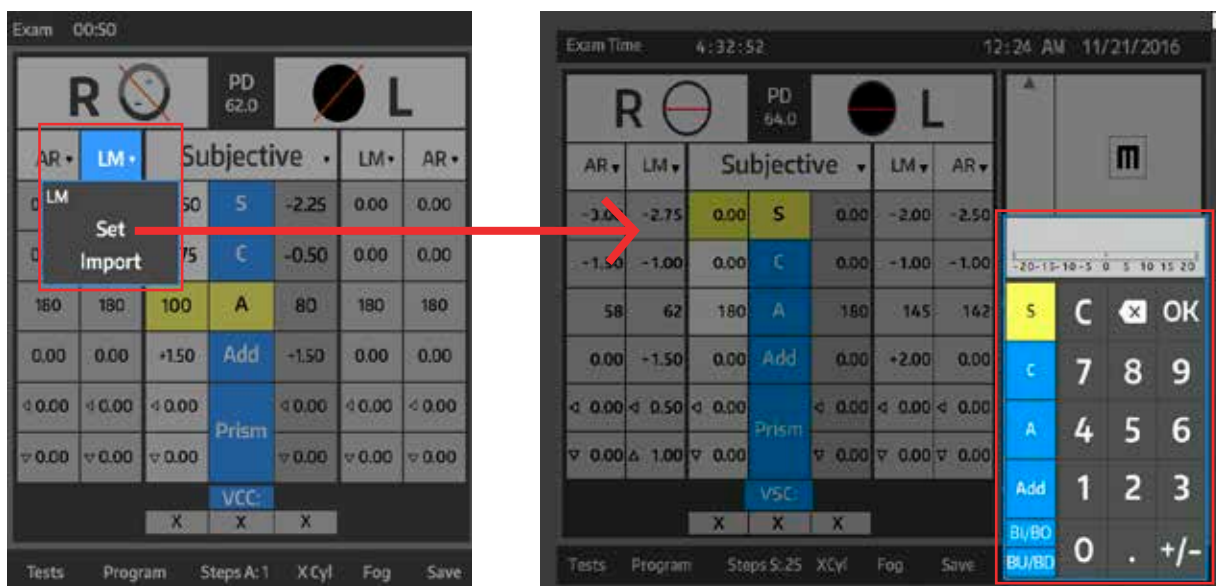

Figure IU-05 Data Input Drop-Down List

Instructions for Use (continued)

Data Input (continued)

Importing Data

Perform the following steps to import data from pretest equipment. Refer to Figure IU-06.

1. Touch the drop-down arrow next to **AR** or **LM**.
2. Touch **IMPORT** in the pop up window.
3. Highlight the information to be imported by touching the data on the screen.
4. Touch **OK** to import the data into the corresponding fields, or **CANCEL** to exit.

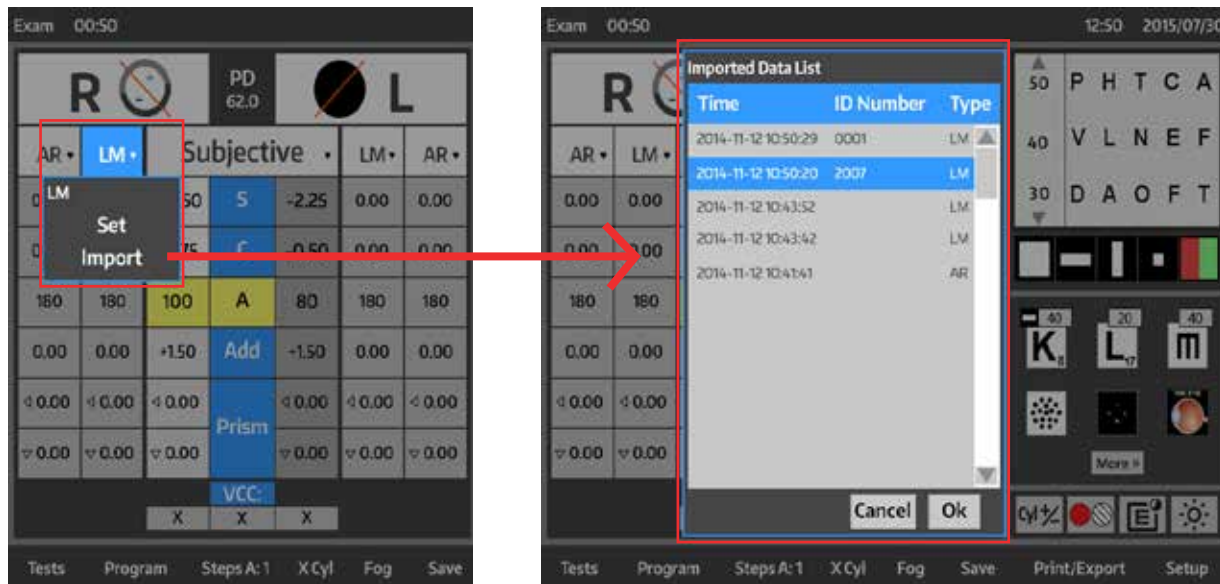

Figure IU-06 Data Input Drop-Down List

Instructions for Use (continued)

Adjust Values

Now that the Phoroptor Head is aligned and the data is imported, a refraction can start.

Adjusting a Refraction From Previously Saved, Transferred, or Input Data

1. Touch the drop-down list in the main display area (e.g., LM, AR).

Note: The data in the boxes is transferred to the refraction data fields and become active.

Note: The Phoroptor Head automatically switches in the lenses to reflect the information in the active field.

2. Select the data to be displayed in the main center field.
3. Adjust measurements from this starting point.
4. Once an adjustment is made, the label will change from the previous label (e.g., LM, AR) to Subjective. Refer to Figure IU-07.

AR	LM	Subjective			LM	AR
-3.00	-2.75	0.00	S	0.00	-2.00	-2.50
-1.50	-1.00	0.00	C	0.00	-1.00	-1.00
58	62	180	A	180	145	142
0.00	+1.50	0.00	Add	0.00	+2.00	0.00
< 0.00	< 0.50	< 0.00	Prism	< 0.00	< 0.00	< 0.00
> 0.00	> 1.00	> 0.00		> 0.00	> 0.00	> 0.00
VSC:						
X	X	X				

Figure IU-07 Values Table

Eye Selection

Touch the **R**, **L**, aperture icon to open/occlude the apertures for the right eye or left eye.

Note: The aperture for the inactive eye automatically occludes during refraction.

Note: The default setting for the open aperture of a new exam is selected in the Setup Menu.

Instructions for Use (continued)

Adjust Values (continued)

Sphere

1. Activate the Sphere value field by touching the **S** box in the main display area of the screen, activating the Sphere value field for both eyes. Refer to Figure IU-08
2. Touch the box to the left or right of the **S** box to activate the Sphere value field for the selected eye.

Note: The Sphere value field is highlighted in yellow, indicating it is active.

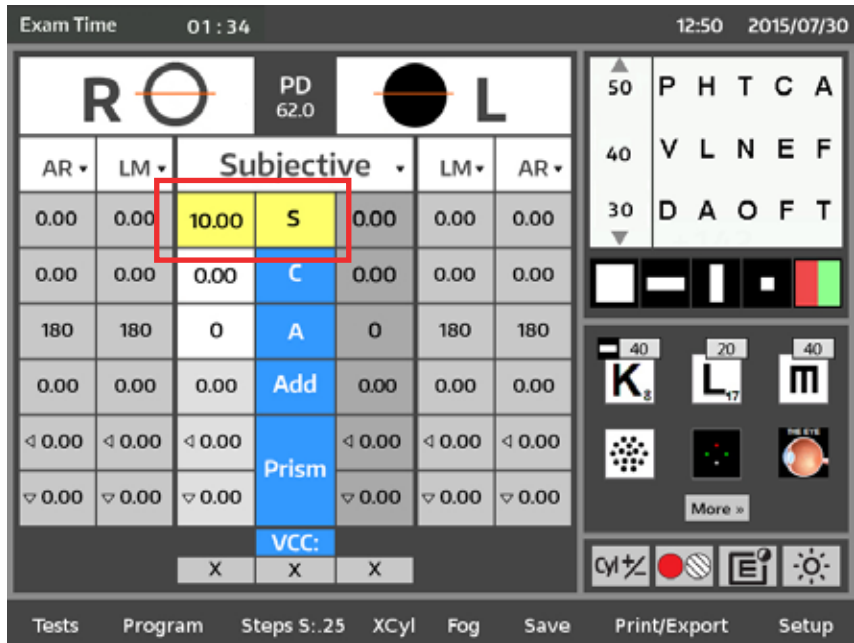

Figure IU-08 Sphere Active Boxes

3. Rotate the **CONTROL KNOB** to adjust the Sphere value.

Note: Rotate the **CONTROL KNOB** to the right to increase plus (+) Sphere value and to the left to increase minus (-) Sphere value.

Note: The increment of change is determined in the Setup Steps Menu, or at the bottom of the screen.

4. Press the **CONTROL KNOB** to move to the next step.

Instructions for Use (continued)

Adjust Values (continued)

Cylinder

1. Activate the Cylinder value field by touching the **C** box in the main display area of the screen, activating the Cylinder value field for both eyes. Refer to Figure IU-09.
2. Touch the box to the left or right of the **C** box to activate the Cylinder value field for the selected eye.

Note: The Cylinder value field is highlighted in yellow, indicating it is active.

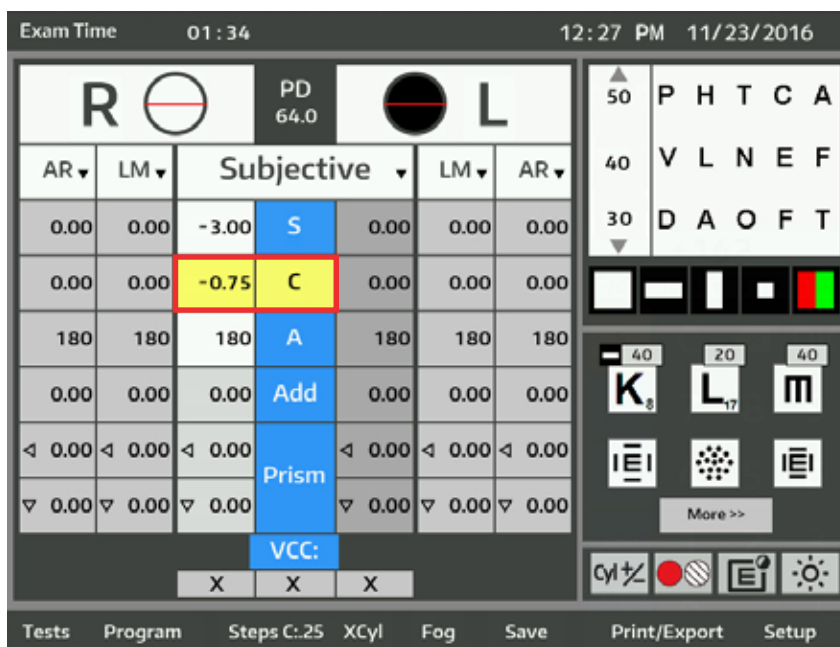

Figure IU-09 Sphere Active Boxes

3. Rotate the **CONTROL KNOB** to adjust the Cylinder value
4. If Minus (-) Cylinder is selected in the Setup Menu, rotate the **CONTROL KNOB** to the left to increase the Cylinder value (Axis on Axis), or rotate the **CONTROL KNOB** to the right to decrease the Cylinder value (Axis against Axis).
5. If Plus (+) Cylinder is selected in the Setup Menu, rotate the **CONTROL KNOB** to the left to decrease the Cylinder value (Axis on Axis), or rotate the **CONTROL KNOB** to the right to increase the Cylinder value (Axis against Axis).
6. If Plus/Minus (\pm) Cylinder is selected in the Setup Menu, rotate the **CONTROL KNOB** to the right to increase Plus Cylinder power and decrease Minus Cylinder power, and rotate the **CONTROL KNOB** to the left to increase Minus Cylinder power and decrease Plus Cylinder power.

Note: The increment of change is determined in the Setup Steps Menu or at the bottom of the screen.

7. Press the **CONTROL KNOB** to move to the next step.

Instructions for Use (continued)

Adjust Values (continued)

Axis

1. Activate the Axis value field by touching the **A** box in the main display area of the screen, activating the Axis value field for both eyes. Refer to Figure IU-10.
2. Touch the box to the left or right of the **A** box to activate the Axis value field for the selected eye.

Note: The Axis value field is highlighted in yellow, indicating it is active.

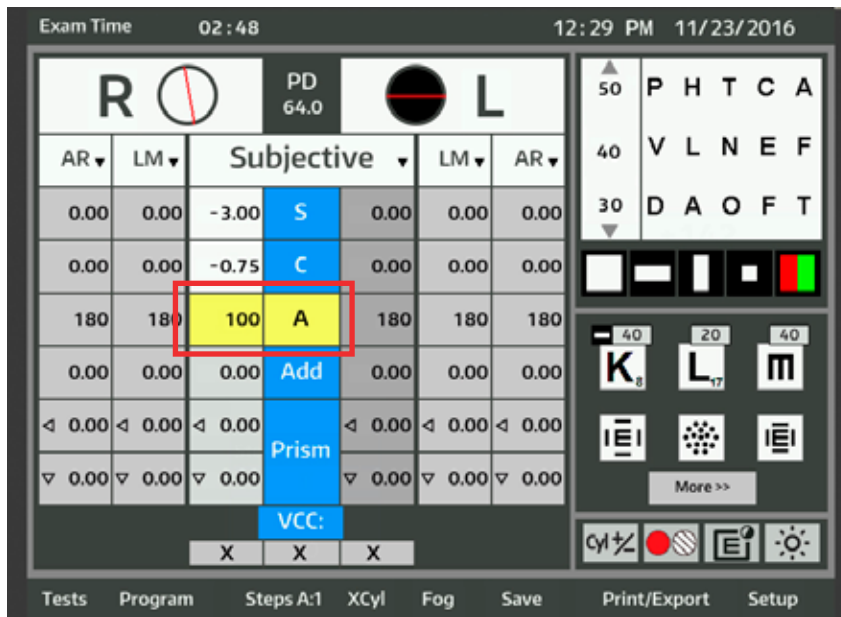

Figure IU-10 Sphere Active Boxes

3. Rotate the **CONTROL KNOB** to adjust the Axis value.

Note: Rotate the **CONTROL KNOB** in either direction to change Axis

Note: The actual position of the Axis is graphically shown on the display in the lens aperture icon.

Note: The increment of change is determined in the Setup Steps Menu or at the bottom of the screen.

4. Press the **CONTROL KNOB** to move to the next step.

Instructions for Use (continued)

Adjust Values (continued)

Near Vision Addition

1. Lower the Near Vision Rod and Card.
2. Touch the **ADD** box in the main display area of the screen, activating the Near Vision Addition value field for both eyes. Refer to Figure IU-11.
3. Touch the box to the left or right of the **ADD** box to activate the Near Vision Addition value field for the selected eye.

Note: Touching the **ADD** box automatically converges the Phoropter head and turns on the Card Illumination Source for the near vision card.

Note: The Near Vision Addition (ADD) field you are changing is highlighted in yellow.

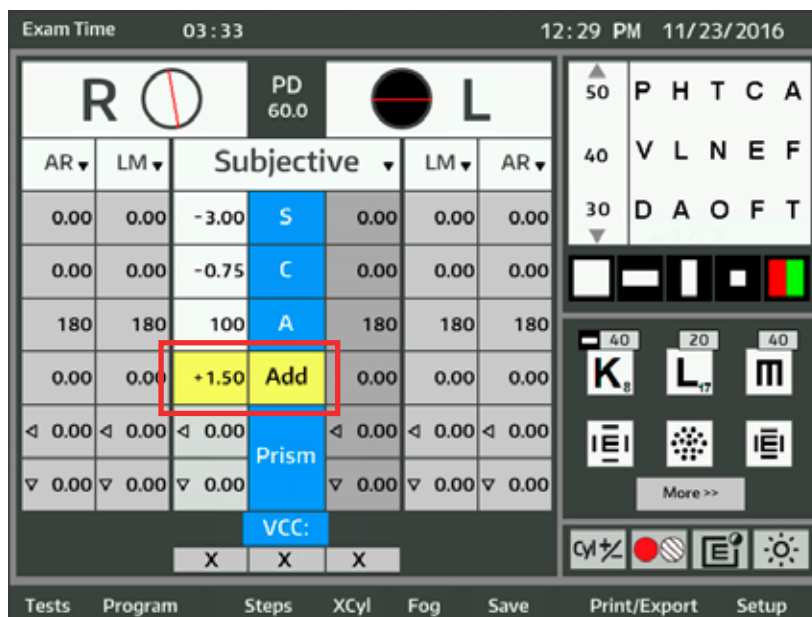

Figure IU-11 Near Vision Addition Active Boxes

4. Verify that you lowered the Near Vision Rod and Card and touched the **ADD** section on the screen.
5. Rotate the **CONTROL KNOB** to adjust the Near Vision Addition value.

Note: Rotate the control knob to the right to increase plus (+) Near Vision Addition value and to the left to decrease plus (+).

Note: The increment of change is determined in the Setup Steps Menu, which corresponds to the steps Sphere is set to.

6. Press the **CONTROL KNOB** to save the value and exit Near Vision mode.

Instructions for Use (continued)

Cross Cylinder

The Cross Cylinder function enables:

- Examination for astigmatism.
- Axis adjustment.
- Cylinder power adjustment.

1. Touch **XCyl** in the menu bar at the bottom of the main screen to activate the Cross Cylinder function.



2. A pop up will appear with three available testing modes: .25, .50 or Split. Refer to Figure IU-12.
3. Touch the desired XCyl examination mode.
4. Touch **EXIT** to close the popup Box



Figure IU-12 Cross-Cylinder Screen

Instructions for Use (continued)

Cross Cylinder (continued)

Examination for Astigmatism

If the Cross Cylinder Mode (XCyl) is activated and a Cylinder value is not present, you need to perform an Astigmatism check. The Astigmatism check automatically activates in each XCYL test mode when no Cylinder power is present. Refer to Figure IU-13.

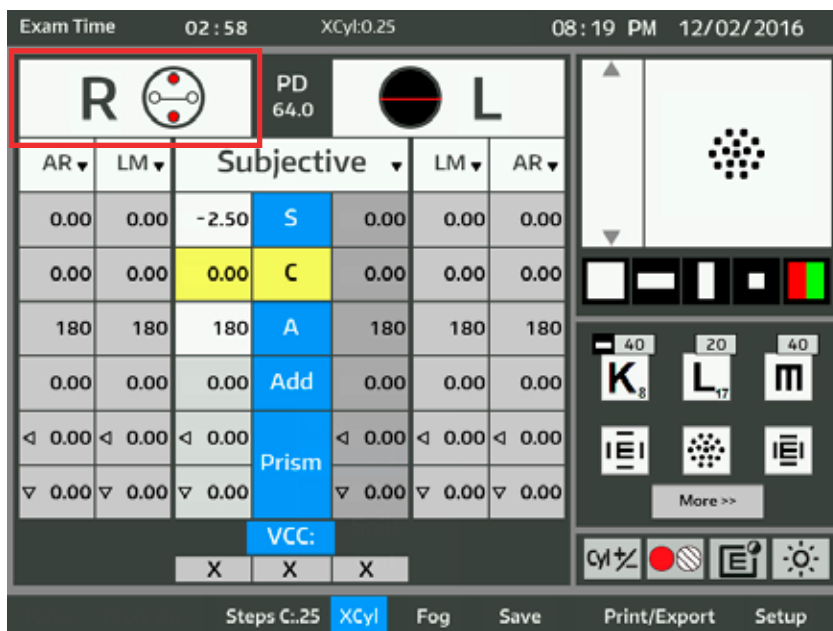

Figure IU-13 Astigmatism Exam

Press the buttons labeled 1 and 2 to present the Cross Cylinder target at 180° and 90°. Ask the patient “which is better, 1 or 2, or the same?”

Patient Responds with Either “1” or “2”:

1. Press the button directly below the preferred button labeled 1 or 2. For example if the patient prefers the image when button 1 is pressed, press the (-) button directly below the button labeled 1.

Note: The test automatically advances to axis adjustment for the XCyl test that was selected.

Patient Responds with “The Same”:

1. If the patient does not see a difference between the two charts, press the **CONTROL KNOB** button.
2. The Cross Cylinder target will change to axis 45° and 135°.
3. Ask the patient to compare two options using buttons labeled 1 and 2.
4. If the patient states the charts are equal, no astigmatic correction is needed. If the patient has a preference press the button directly below the button labeled 1 or 2.

Note: The test automatically advances to axis adjustment for the XCyl test that was selected.

Instructions for Use (continued)

Cross Cylinder (continued)

Single Target Presentation

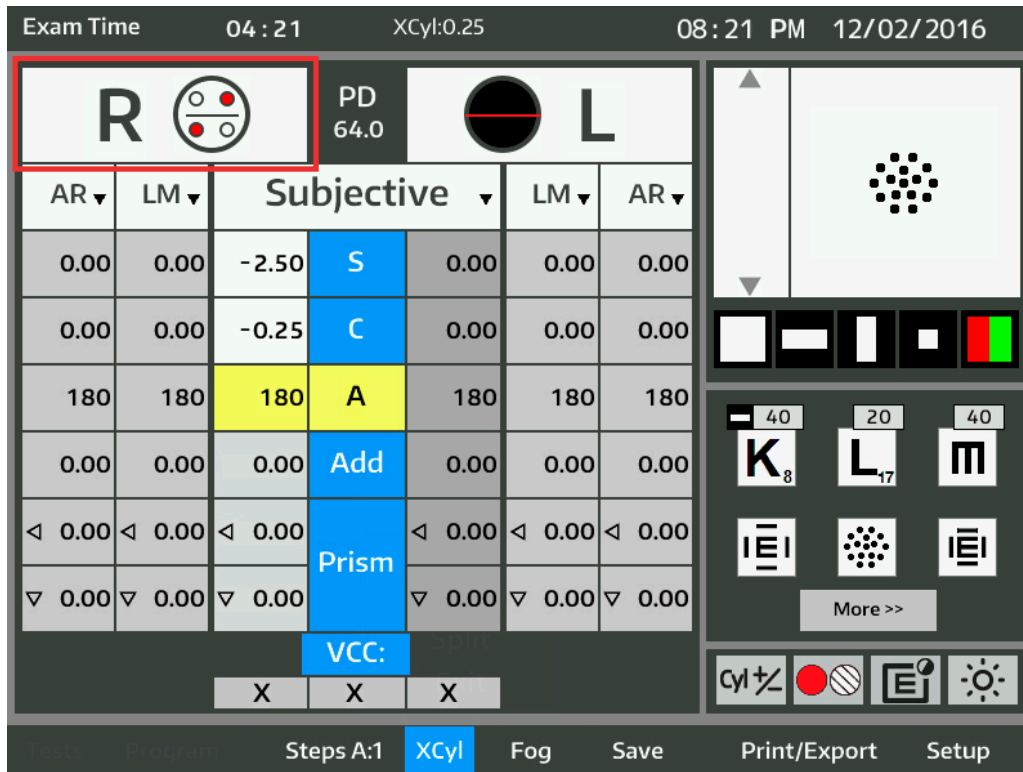

Figure IU-14 Cross Cylinder - Smart Test Screen

Axis Adjustment

Spherical equivalent is maintained during the Cylinder power adjustment. If no Cylinder power is present, the Astigmatism check is done first, followed by the Axis adjustment. The default chart selected for the XCyl test is presented to the patient. If no default chart was selected, refer to the **Selecting Default Charts** section of this manual.

Note: The Cross Cylinder test is performed monocularly.

1. Touch Steps A:1°,5° or 10° to select the increment of axis change.
2. Press the buttons labeled 1 and 2 to present the Cross Cylinder targets.
3. Ask the patient “which is better, 1 or 2, or the same?”
4. If the patient states a preference, press the button directly below the preferred button labeled 1 or 2. For example if the patient prefers the image when button 1 is pressed, press the (-) button directly below the button labeled 1. Repeat “Which is better (sharper and clearer), 1 or 2 or the same?” until they are equal or the patient reverses the preferred button.
5. Return to the Step A:x and select a smaller increment degree and repeat the procedure. The user can determine the point where axis alignment is achieved.
6. Press the **CONTROL KNOB** to move to cylinder power determination.

Instructions for Use (continued)

Cross Cylinder (continued)

Cylinder Power (JCC) Adjustment

1. Confirm the XCyl is enabled and the C box is highlighted in yellow. Refer to Figure IU-15.
2. The default chart selected for the XCyl test is presented to the patient. If no default chart was selected, refer to the **Selecting Default Charts** section of this manual.
3. Touch Steps C:.25 or .50 to select the increment of power change.
4. Press the buttons labeled 1 and 2 to present the Cross Cylinder options.
5. Ask the patient “which is better, 1 or 2, or the same?”
6. If the patient states a preference, press the button directly below the preferred button labeled 1 or 2. For example if the patient prefers the image when button 1 is pressed, press the (-) button directly below the button labeled 1.
7. Repeat “Which is better, 1 or 2, or the same?” until they are equal or the patient reverses the preferred button.
8. If equal, press the **CONTROL KNOB** to end the XCyl test. Otherwise, return to the Steps C:x and select a smaller value and repeat the procedure

Note: If the patient goes back and forth in a ± 0.25 D change in power, select a position and end the test by pressing the **CONTROL KNOB**.

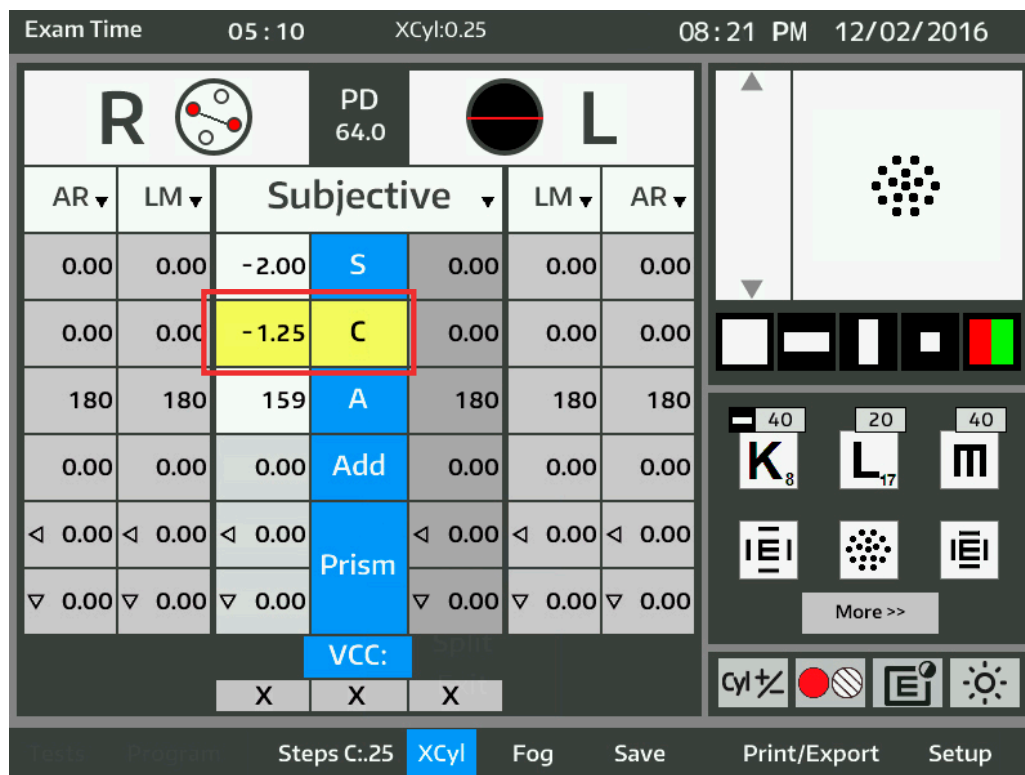

Figure IU-15 Cross-Cylinder Screen

Instructions for Use (continued)

Cross Cylinder (continued)

Split Cyl Test

The Split Cyl Cross Cylinder test allows the patient to see two identical side by side test charts when adjusting Axis and Cylinder, making it easier for the patient to compare different Axis positions and Cylinder power values. Refer to Figure IU-16.

The patient indicates to the examiner which test chart appears clearer, by stating whether the chart corresponding to the right/left or top/bottom of the lens appears clearer.

1. Touch **XCyl** on the menu bar at the bottom of the main screen.
2. Touch **Split** to start the test.
3. If no cylinder is detected, then perform the steps in **Examination for Astigmatism**.

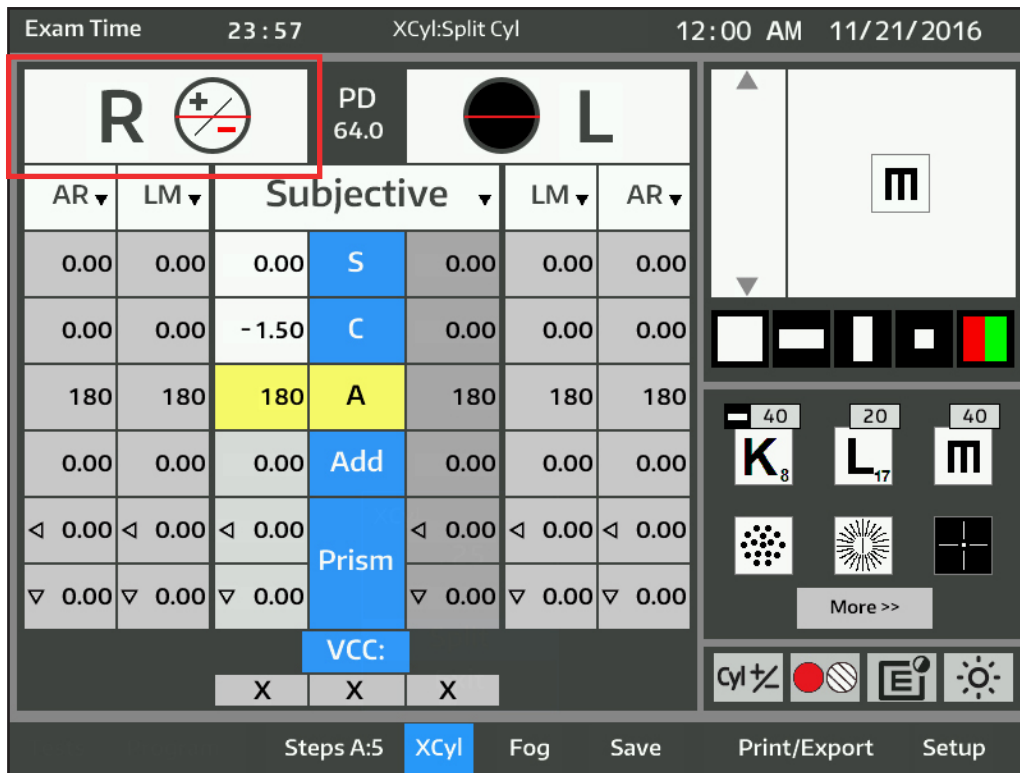

Figure IU-16 Cross Cylinder - Split Cyl Test Screen

Instructions for Use (continued)

Cross Cylinder (continued)

Split Cyl Test (continued)

Axis Adjustment

1. Touch the screen icon Steps A:x at the bottom of the screen that indicates the degree of Axis change. Refer to Figure IU-17.

Note: The degree of Axis change increments are 1°, 5°, or 10°.

2. Ensure that the patient is positioned so that they can see 2 identical images.
3. Ask the patient: "Which is better, the right/left or top/bottom?"
4. Press the **MINUS** or **PLUS** button as indicated on the aperture graphic based on the patient's response.
5. Repeat steps 3 and 4, until the patient sees the two test charts that are the same.
6. Touch the screen icon Steps A: and decrease the increment value.
7. Press the **MINUS** or **PLUS** button as indicated on the aperture graphic based on the patient's response.
8. Repeat steps 3 and 4, until the patient sees the two test charts that are the same.
9. Press the **CONTROL KNOB** button

Note: Axis is freely adjustable by rotating the **CONTROL KNOB**.

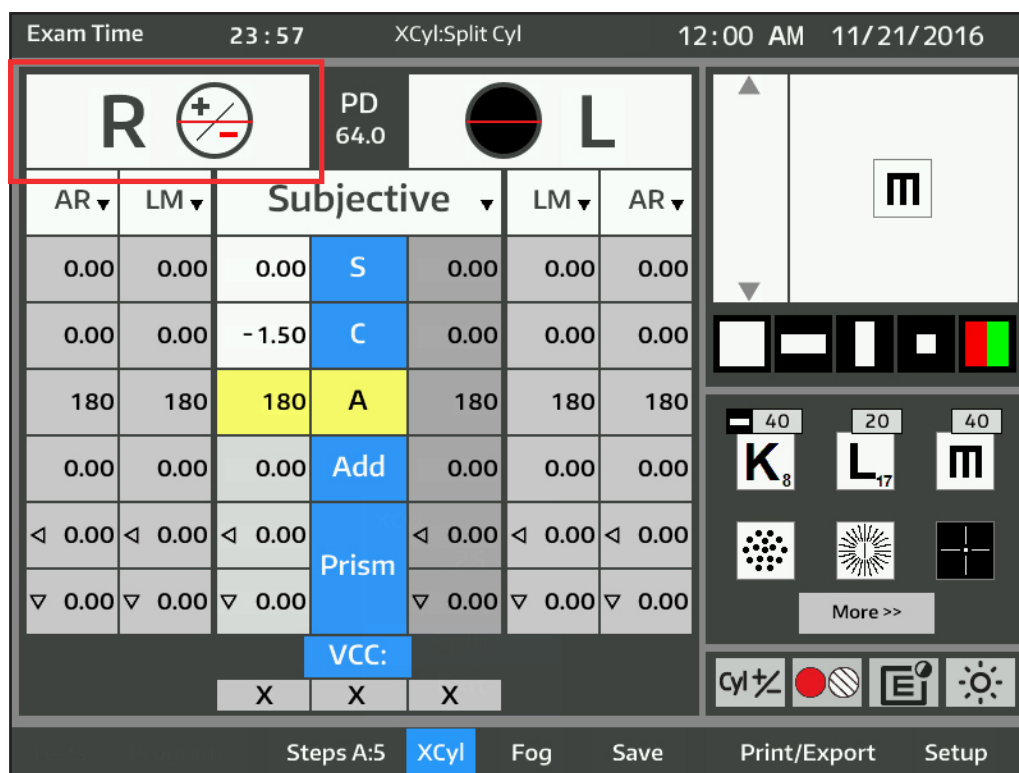

Figure IU-17 Cross Cylinder - Split Cyl Test Screen

Instructions for Use (continued)

Cross Cylinder (continued)

Split Cyl Test (continued)

Cylinder Power Adjustment

Once the Axis adjustment is complete, the Split Prism Cross Cylinder test automatically advances to the Cylinder power adjustment. Refer to Figure IU-18.

1. Ask the patient: “Which is better, the right/left or top/bottom?”
2. Press the **MINUS** or **PLUS** button as indicated on the aperture graphic based on the patient’s response.
3. Repeat steps 2 and 3, until the patient sees the two test chart images equally clear or equally blurry.
4. Press the **CONTROL KNOB** button, to save the Cylinder value. This completes the Split Cyl Cross Cylinder test.

Note: Cylinder power is freely adjustable by rotating the **CONTROL KNOB**.

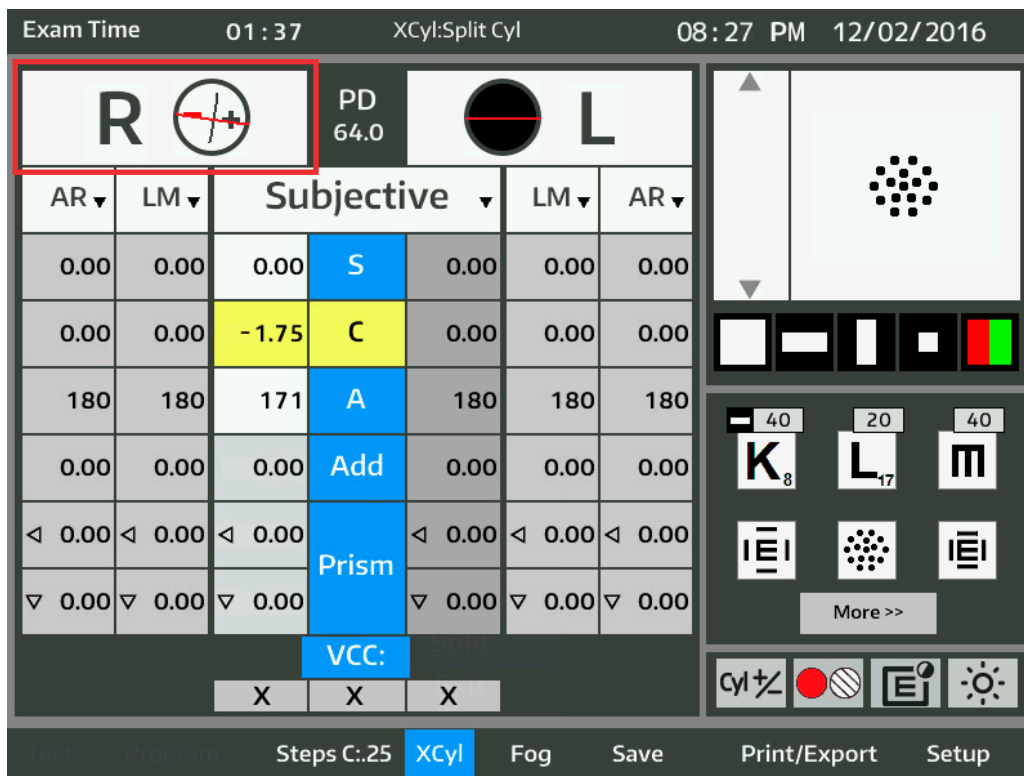

Figure IU-18 Cross Cylinder - Near Vision Test Screen

Instructions for Use (continued)

Near Vision Test

If required, perform a Near Vision test with the Near Vision Card on the Near Vision rod.

1. Touch ADD on the main screen. Refer to Figure IU-19.
 - Both apertures are open.
 - Both refractor halves converge to 15.75 in. (40 cm)
 - The Illumination Source is turned on when the ADD icon is selected

Note: Adjust the PD if necessary. Refer to the Aligning the Phoropter Head section of this manual.

2. Lower the Near Vision rod.
3. Rotate the **CONTROL KNOB** to the right to add power. Increments are determined in Setup Steps.

Note: Ensure that the patient's forehead is positioned against the forehead rest.

4. When the Near Vision test is completed, raise the Near Vision rod.
5. Touch the S box to remove the ADD lenses.

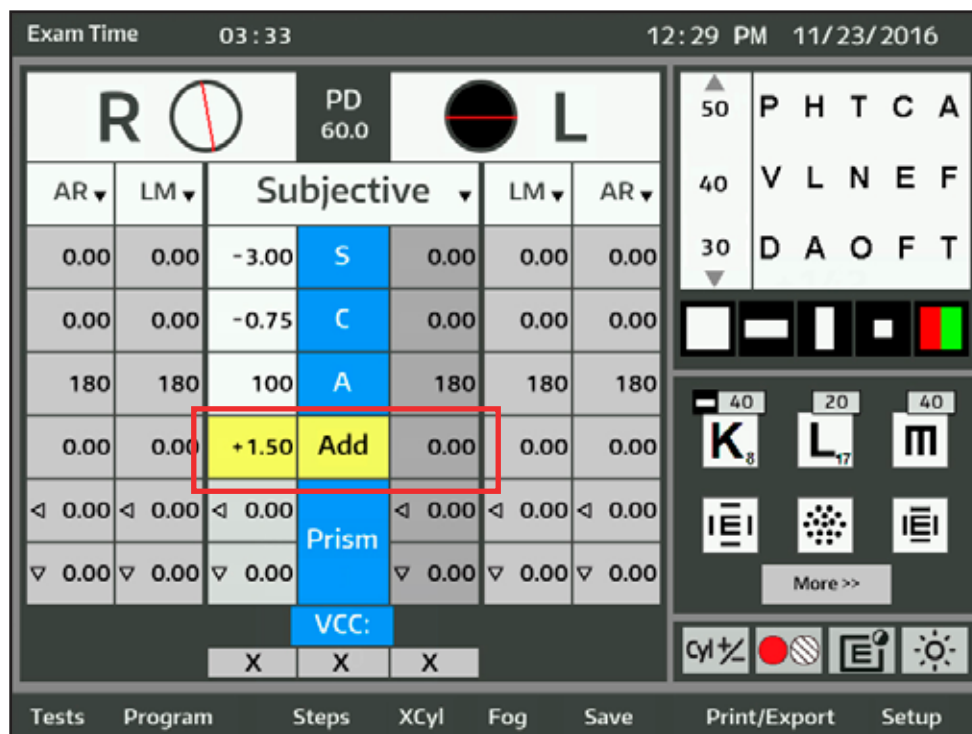

Figure IU-19 Cross Cylinder - Near Vision Test Screen

Instructions for Use (continued)

Near Vision Test (continued)

Fused Cross Cylinder Test

1. Touch **TESTS** and select Fused XCyl
2. Use the Cross Grid Chart on the reading card.

Note: The Fixed Cross Cylinder lenses (+0.50 D, Axis 90°) are placed in the lens apertures. Refer to Figure IU-20.

3. Ask the patient: “Which is better (sharper and clearer), the horizontal or the vertical lines?”
4. Rotate the **CONTROL KNOB** to add plus (+) power.

Note: The .12 Step is not available in Fused XCyl

5. Repeat steps 3 and 4, until the patient states that the horizontal and vertical lines appear equal.
6. Press the **CONTROL KNOB**.

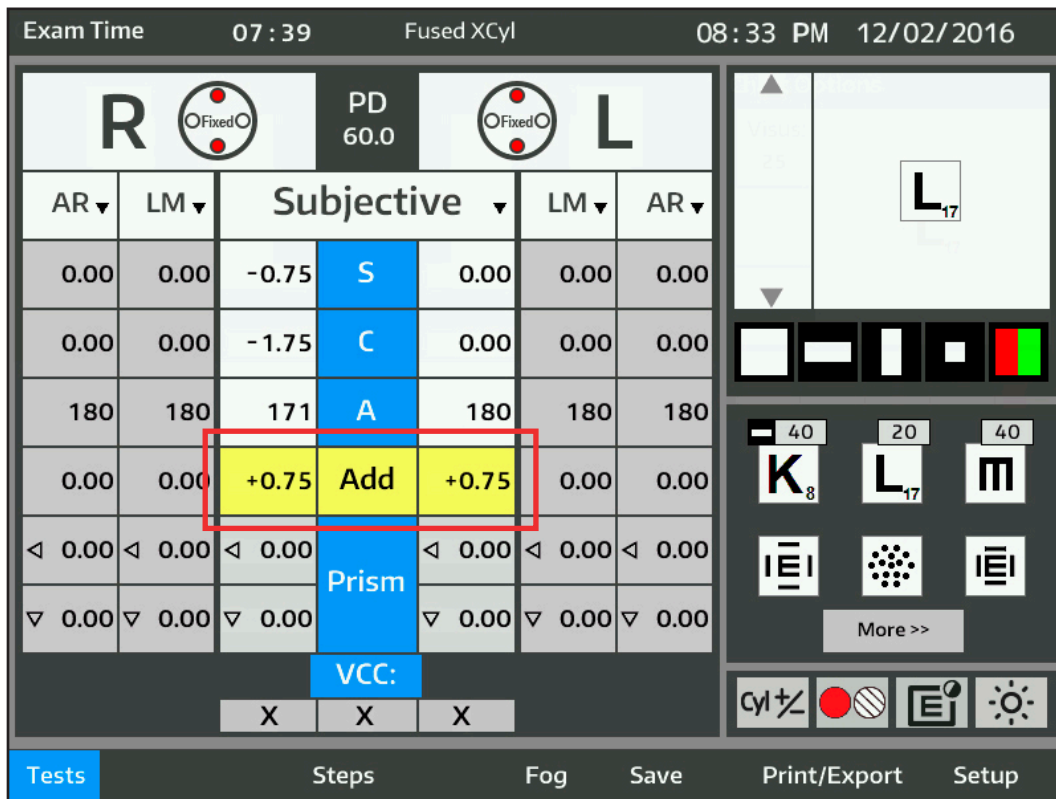

Figure IU-20 Fused XCyl Test

Instructions for Use (continued)

Prism Testing

1. Touch **PRISM** to begin the Prism test. Refer to Figure IU-21.

Note: The small triangles next to the Prism box on the data table indicate the orientation and direction of the Prism in each eye:

- ◀ = Horizontal prism - Right Eye: Base In (BI), Left Eye: Base Out (BO)
- ▶ = Horizontal prism - Right Eye: Base Out (BO), Left Eye: Base In (BI)
- ▼ = Vertical prism - Right Eye and Left Eye: Base Up (BU)
- ▲ = Vertical prism - Right and Left Eye: Base Down (BD)

Note: Increments are of 0.1, 0.5 or 1 are selected in Setup Steps

Note: XY (Cartesian) or Polar values are selected in Setup Steps

2. Touch the box on the screen for the eye and the prism base orientation (horizontal or vertical) that needs adjustment.
3. Rotate the **CONTROL KNOB** to add Prism in either the right or left eye.

Note: The prism operates from 0-20Δ.

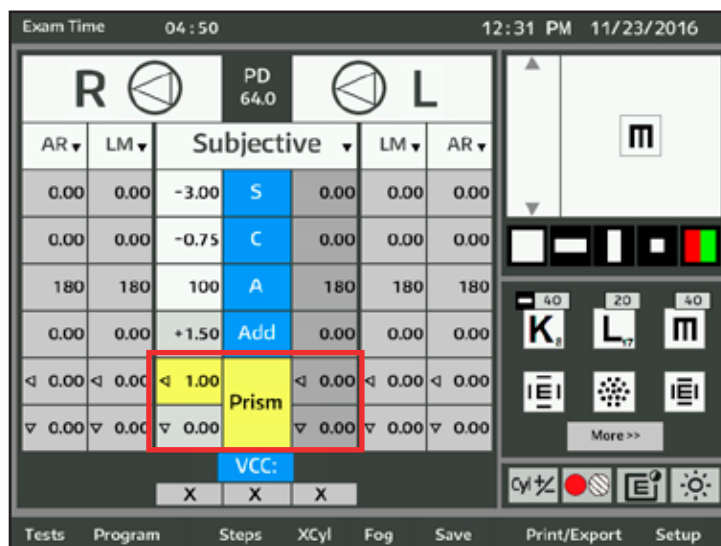

Figure IU-21 Adjust Prism Values

Horizontal Prism - Right Eye

- Rotate the **CONTROL KNOB** left to add BO prism in 0.25 D increments.
- Rotate the **CONTROL KNOB** right to add BI prism in 0.25 D increments.

Horizontal Prism - Left Eye

- Rotate the **CONTROL KNOB** left to add BI prism.
- Rotate the **CONTROL KNOB** right to add BO prism.

Vertical Prism - Right and Left Eye

- Rotate the **CONTROL KNOB** right to add BU prism.
- Rotate the **CONTROL KNOB** left to add BD prism.

Instructions for Use (continued)

Prism Testing (continued)

Horizontal Phoria Test

1. Touch **TESTS** and **PHORIA**. Refer to **Figure IU-22**.
2. Select an appropriate test chart of a single vertical line of optotypes or a single optotype. The default chart selected for the phoria test is presented to the patient. If no default chart was selected, refer to the **Selecting Default Charts** section of this manual. Refer to **Figure IU-27**.
3. Verify that the patient can see two images, one up and one down.
4. Enter BO Prism or add more BI Prism, if the patient cannot see two targets.
5. Enter BO Prism, until the two images align, like buttons on a shirt.
6. Press the **CONTROL KNOB**.

Note: The magnitude of lateral Phoria is the power of the Prism when the images are aligned.

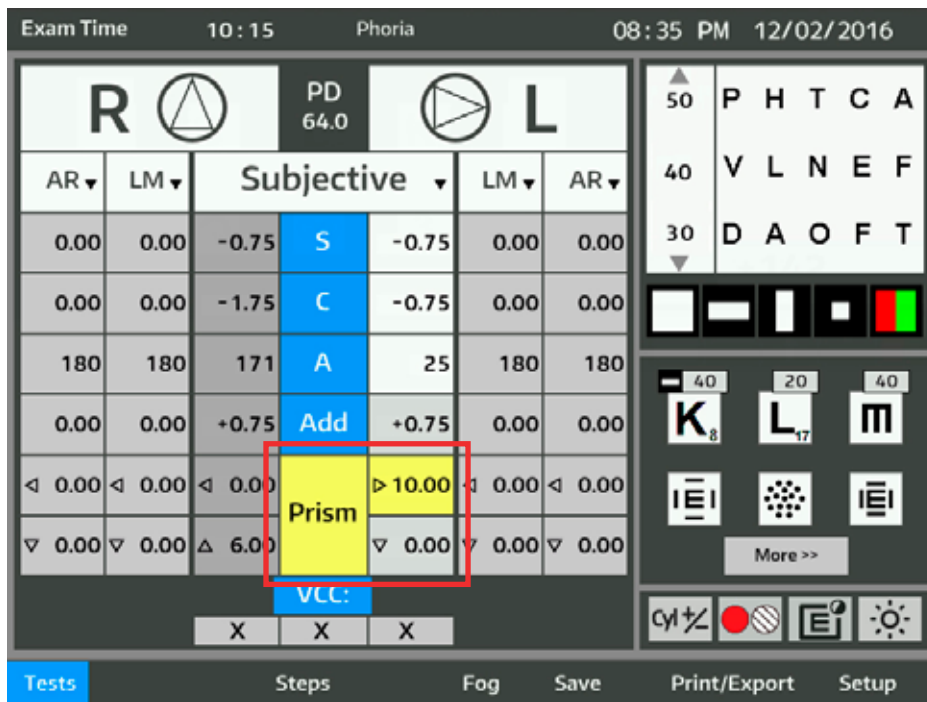

Figure IU-22 Vertical Phoria Test Screen

Instructions for Use (continued)

Prism Testing (continued)

Vertical Phoria Test

After the horizontal phoria is determined, the Prism power is restored to 10 BI Prism in the left eye, as a starting value for the vertical phoria test. Refer to Figure IU-23.

1. Select an appropriate test chart of a single horizontal line of optotypes or a single optotype. The default chart selected for the phoria test is presented to the patient. If no default chart was selected, refer to the **Selecting Default Charts** section of this manual.
2. Verify that the patient can see two images.
3. Enter BU Prism until the two images align horizontally, like headlights on a car to measure the vertical phoria.
4. Press the **CONTROL KNOB** to end the test.

Note: The magnitude of the vertical Phoria is the power of the Prism when the images are aligned.

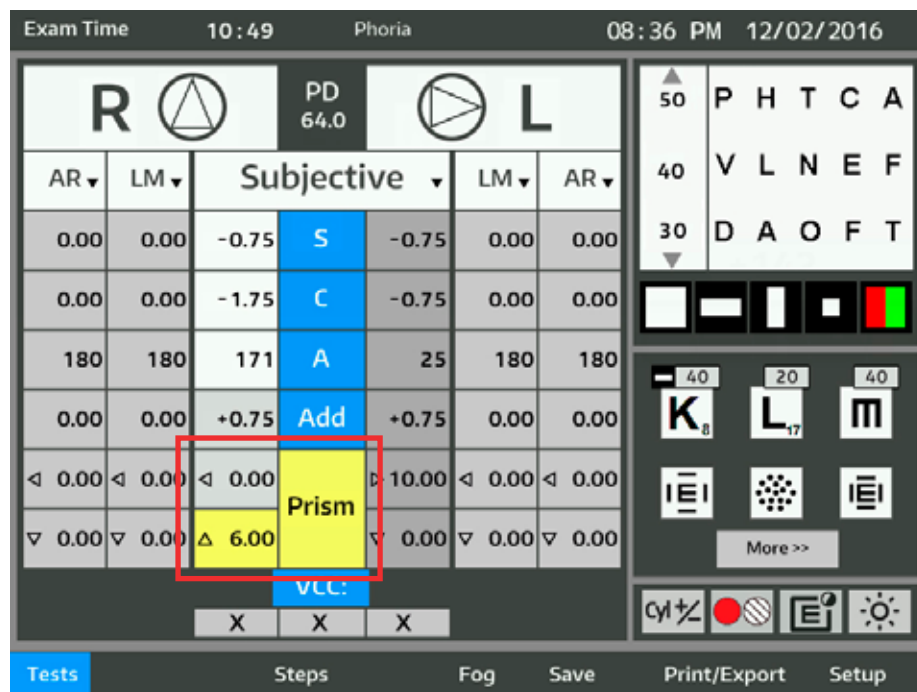

Figure IU-23 Vertical Phoria Test Screen

Instructions for Use (continued)

Prism Testing (continued)

Binocular Balance with Prisms

Use binocular balance with prism to determine if the monocular VAs are the same.

1. Touch **TESTS** and then **BB**, on the main screen to begin the Binocular Balance prism test. Refer to Figure IU-24.

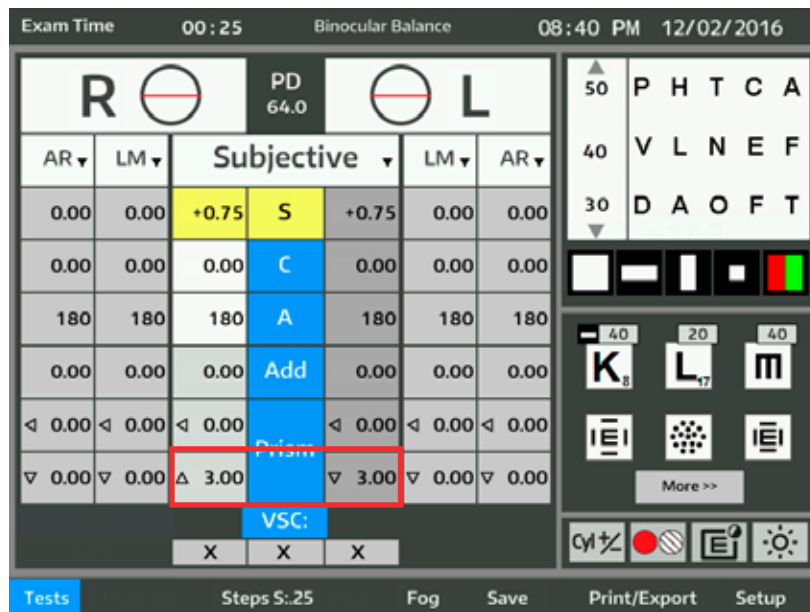

Figure IU-24 Binocular Balance with Prisms

2. Set the acuity chart to a single horizontal line of optotypes at slightly better than best visual acuity for the patient, or a single optotype. The default chart selected for the BB test is presented to the patient. If no default chart was selected, refer to the **Selecting Default Charts** section of this manual
3. The Binocular Balance test automatically places prism in each eye (3D BD in the right eye and 3D BU in the left eye).
4. Verify that the patient can see two images, one up and one down.
5. Touch **PRISM** to adjust the Prism values if the patient cannot see two images.

Note: The sphere values automatically fog by the amount specified in the Settings Menu.

6. Ask the patient: "Which image is clearer, the top or the bottom, or the same?"
7. If the top image is clearer, adjust sphere in the right eye. If the bottom image is clearer, adjust sphere in the left eye.
8. Add sphere power to the eye that sees a clearer image until both lines look equal, either by rotating the **CONTROL KNOB** or by pressing the **+** button.

Note: The goal is to get the images to appear the same to the patient.

Note: Increment is determined in **SETUP STEPS**.

9. Press the **CONTROL KNOB TWICE** to remove the prism.
10. Decrease sphere in both eyes to reach the best visual acuity.

Instructions for Use (continued)

Saving Visual Acuity - Distance

You can save visual acuity for monocular and binocular vision for both unaided and aided visual acuity. Refer to Figures IU-25 & IU-26.

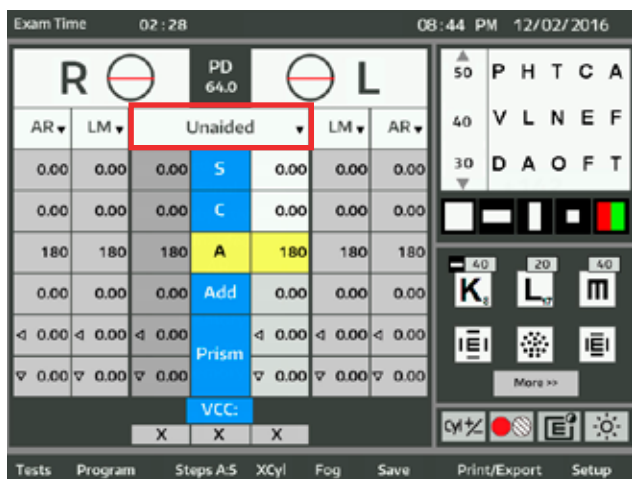

Figure IU-25 VSC - Vision Without Correction

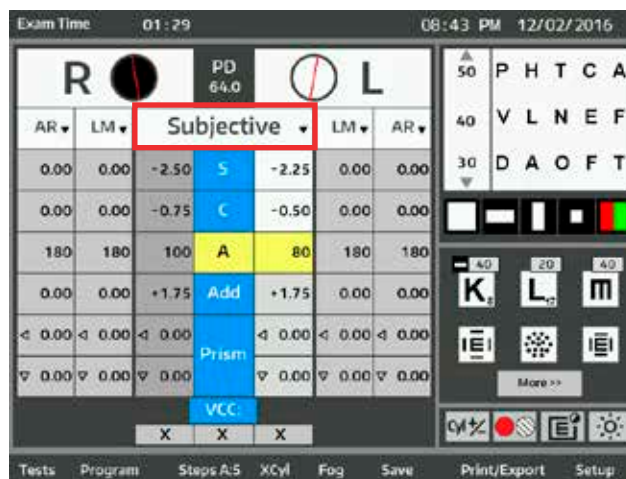

Figure IU-26 VCC - Vision With Correction

Right Eye

1. Touch the right sphere, cylinder, or axis value boxes to isolate the right eye.
2. Show the patient a chart of multiple lines of optotypes.
3. Ask the patient to choose the smallest line of optotypes they can read.
4. Touch the number on the screen next to that line (e.g., “20” for Snellen optotypes or 1.0 for Decimal optotypes).

Note: VSC = Vision (without correction)
VCC = Vision (with correction)

Note: This saves the visual acuity for the right eye, which appears in the data field for the right eye in the VSC or VCC box.

Left Eye

1. Touch the left sphere, cylinder, or axis value boxes to isolate the left eye.
2. Show the patient a chart of multiple lines of optotypes.
3. Ask the patient to choose the smallest line of optotypes they can read.
4. Touch the number on the screen next to that line (e.g., “20” for Snellen optotypes or 1.0 for Decimal optotypes).

Note: This saves the visual acuity for the left eye, which appears in the data field for the left eye in the VSC or VCC box.

Instructions for Use (continued)

Saving Visual Acuity - Distance (continued)

Binocular Vision

1. Touch the center S, C, or A icons so both apertures (right and left) open to measure. Refer to Figure IU-27
2. Show the patient a chart of multiple lines of optotypes.
3. Ask the patient to choose the smallest line of optotypes they can read.
4. Touch the number on the screen next to that line (e.g., "20" for Snellen optotypes or 1.0 for Decimal optotypes).

Note: This saves the visual acuity for Binocular Vision, which appears in the middle data field in the VSC or VCC box.

Note: Follow the same steps for Visual Acuity - Near as was done with Visual Acuity - Distance.

Note: The VSC and VCC boxes change to VSC-N and VCC-N when working with Visual Acuity - Near.

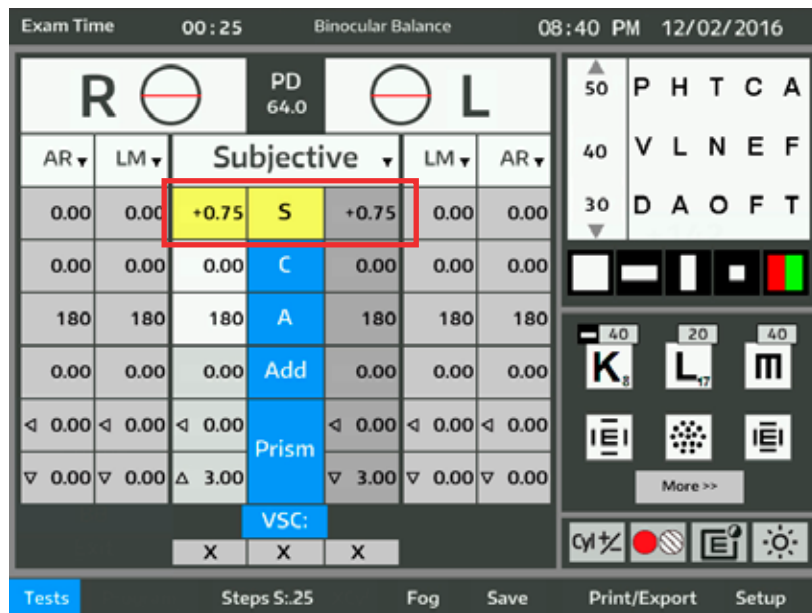

Figure IU-27 Binocular Balance with Prisms

Instructions for Use (continued)

Saving Refraction Data

Save the measurements temporarily as Final, Memory 1, Memory 2, or Memory 3, or leave the data as Subjective, once the values for a refraction are completed. Saving different data in Memory 1, Memory 2, or Memory 3 allows the option of comparing different refraction data you are considering for your patient's prescription. Refer to Figure IU-28.

1. Touch **SAVE** on the bottom on the screen.
2. Touch the drop-down list on the top of the main refraction data area.
3. Select the category to which you want to save the refraction data.

Note: You can save and recall the refraction data for comparison or measurement values.

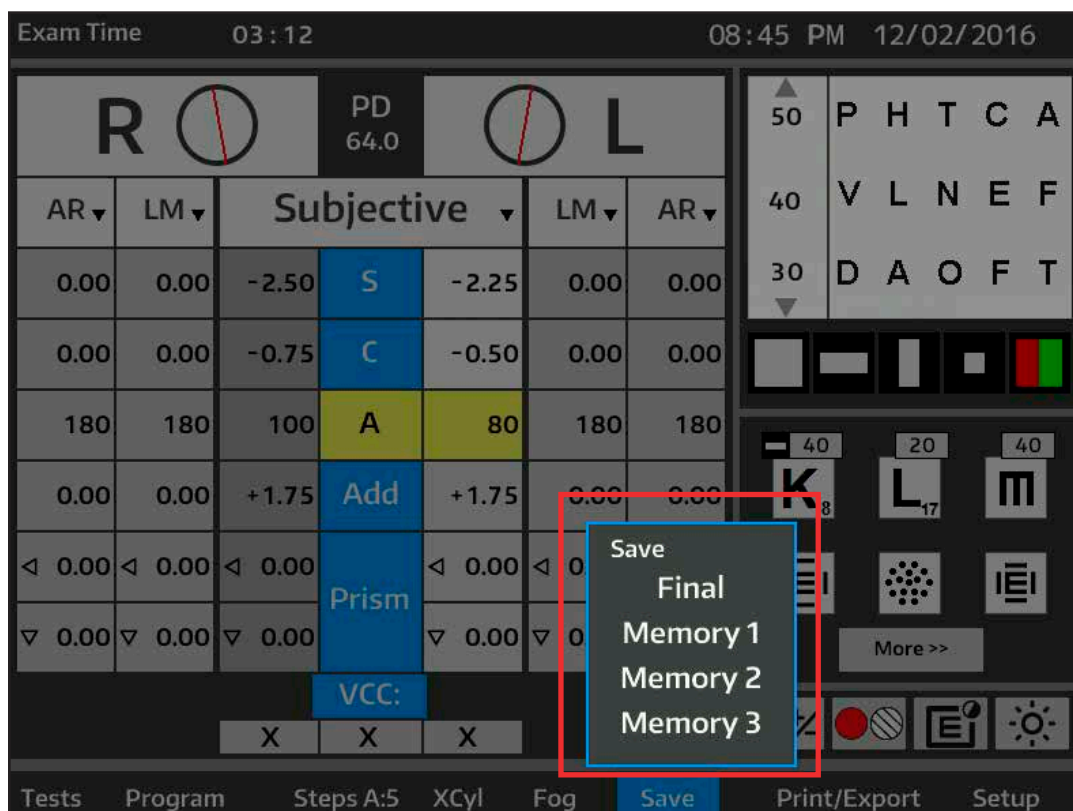

Figure IU-28 Saving Refraction Data

Comparing Refraction Data

One of the advantages of a digital refractor is the ability to quickly and easily compare different refractions with a touch of the screen, enabling patients to see the difference between their old and new prescriptions, or the difference between two possible prescriptions and even without a prescription.

After completing a refraction, you can switch between a saved measurement and the current measurements, as needed, enabling comparison of different prescriptions.

Note: Once data is transferred to the active data field, the Phoropter Head changes the lenses to reflect that data. This allows for easy comparison between different measurements.

Touch the drop-down list at the top of the main refraction data area to select and compare different types of refraction data, including Final, Subjective, SC (Unaided), AR (Auto Refractor), LM (Lensometer), Memory 1, Memory 2, and Memory 3. Refer to Figure IU-29.

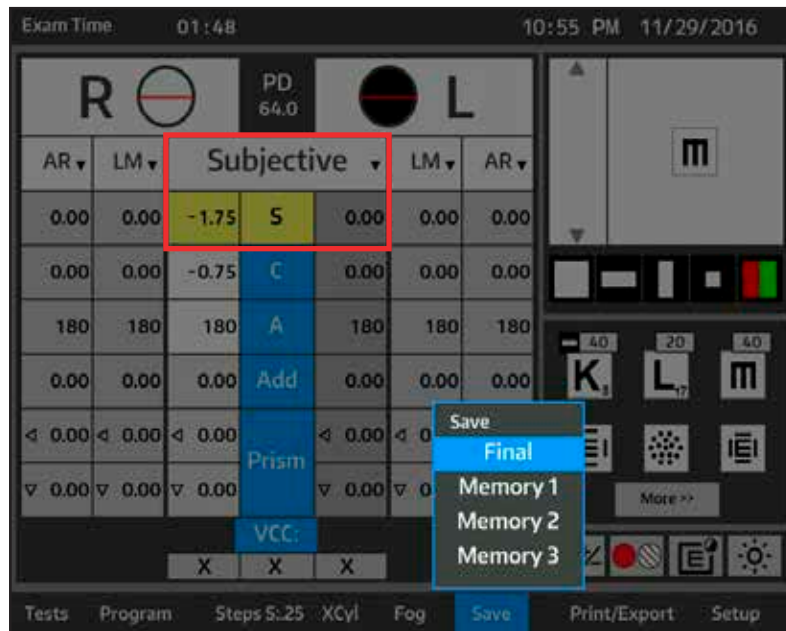

Figure IU-29 Comparing Different Measurements

Instructions for Use (continued)

Data Transfer

It is essential to either send the Final refraction data to an EMR system or the printer before clearing data and preparing for the next patient.

Note: Once data is cleared, it is permanently deleted. The Final Refraction data is not saved in the SightChek hard drive, so it cannot be recalled for reference or data transfer after the information is cleared.

Data output options for refraction results include sending data electronically to an EMR system, printing the data, and manually recording it. Results are both printed and sent to an EMR system, as long as the user configures the printer and EMR ports for output in the **SETUP** menu. Refer to Figure IU-30.

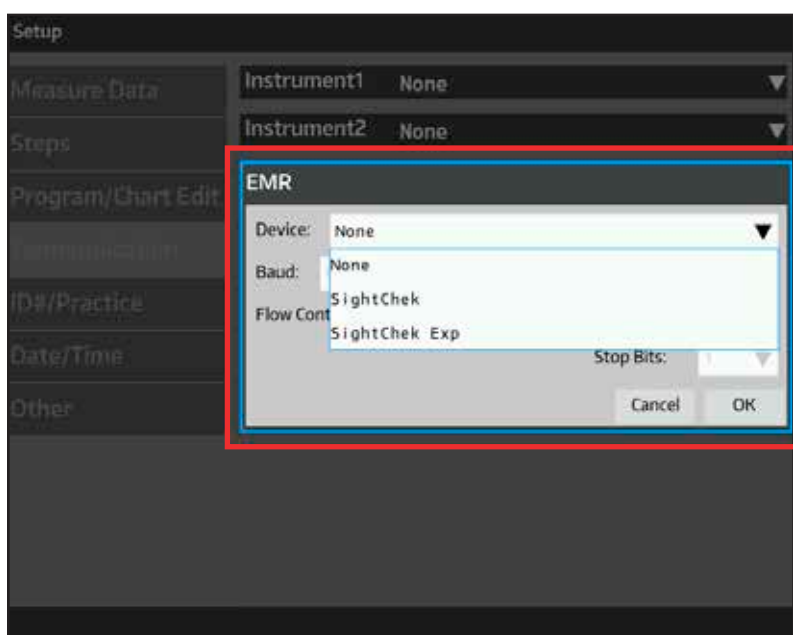

Figure IU-30 EMR Settings

EMR Output Options

1. SightChek - Sends SightChek final refraction data only
2. SightChek Exp - Sends SightChek, Auto Refractor, and Lensometer data.

Note: The default data that is sent to the EMR system or the printer is Final refraction data. If you do not save the measurement results as Final refraction data, the Subjective refraction data is sent.

3. Touch **PRINT/EXPORT** to transfer the data to an EMR system.



Note: Data output is configured in **SETUP OTHER** and can be directed to the Printer, PC, or Both.

Instructions for Use (continued)

Data Transfer (continued)

Data Output

Each patient data record includes:

- Sphere (Right and Left Eye, Far and Near)
- Cylinder (Right and Left Eye)
- Axis (Right and Left Eye)
- Prism (Right and Left Eye)
- Visual Acuity Distance Unaided and Aided (Right Eye, Left Eye, Binocular)
- Visual Acuity Near Unaided and Aided (Right Eye, Left Eye, Binocular)
- Vertex Distance
- Pupillary Distance
- Lensometer (If SightChek Exp is selected in the SETUP menu.)
- Auto Refractor (If SightChek Exp is selected in the SETUP menu.)

Data can be transferred either through ReichertCapture, or through a direct connection. In order to transfer data from the SightChek to your EMR system, you need to download ReichertCapture™ Software, or have your EMR provider establish a serial connection. You can download the ReichertCapture Software and the ReichertCapture User Guide from www.Reichert.com.

Instructions for Use (continued)

Printing

1. To enable the built-in printer Select **PRINTER** from the **SETUP OTHER** section. Refer to Figure IU-31.

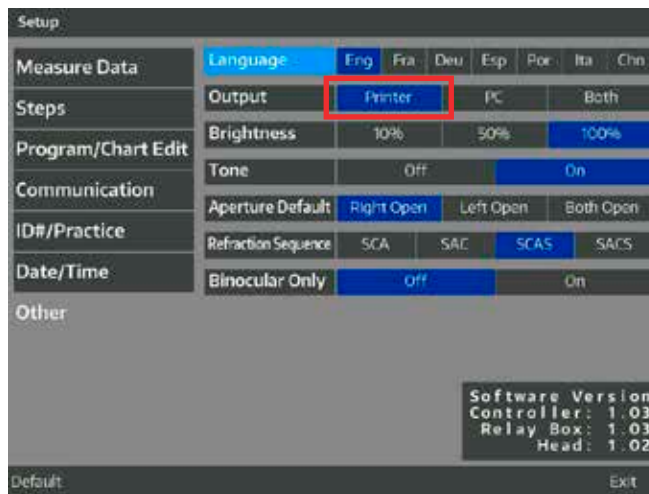

Figure IU-31 Printer Settings

This is a sample of the printer data output. Refer to Figure IU-32.

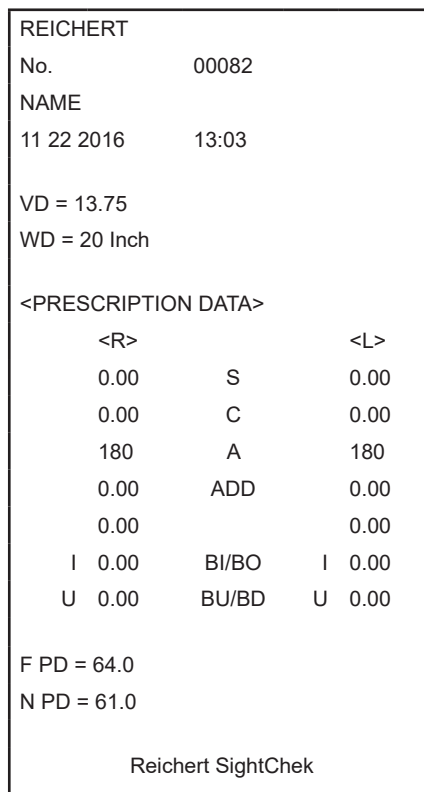

Figure IU-32 Sample Printout

Instructions for Use (continued)

Printing (continued)

Printer Data Output

Press **PRINT/EXPORT** on the screen to print the data.

You can send the following information to the printer:

- Date and Time
- Sphere (Right and Left Eye, Far and Near)
- Cylinder (Right and Left Eye)
- Axis (Right and Left Eye)
- ADD
- Prism (Right and Left Eye)
- Vertex Distance
- Pupillary Distance
- Visual Acuity Distance Unaided and Aided (Right Eye, Left Eye, Binocular)
- Far/Near PD

Clearing All Data

1. Press the **C** button. A warning box appears. Refer to Figure IU-33.
2. Either touch **YES** on the screen, or press the **C** button again to clear the data. This permanently clears all the data in the active refraction fields and all the storage boxes. Cancel will abort the clearing of data.
3. PD returns to 64 mm.

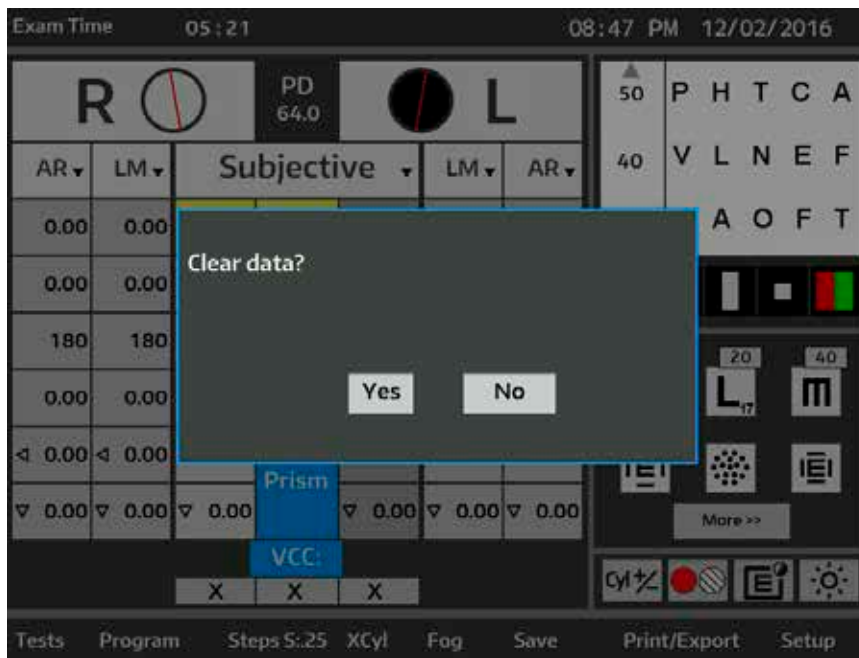

Figure IU-33 Clearing Data

Cleaning and Maintenance

WARNING: ANY REPAIR OR SERVICE TO THIS INSTRUMENT MUST BE PERFORMED BY EXPERIENCED PERSONNEL OR DEALERS THAT ARE TRAINED BY REICHERT SO THAT CORRECT OPERATION OF THIS INSTRUMENT IS MAINTAINED.

WARNING: ALWAYS UNPLUG THE POWER CORD BEFORE CLEANING ANY SURFACE ON THE INSTRUMENT.

CAUTION: INGRESS PROTECTION CLASSIFICATION FOR THE INSTRUMENT IS IPX0. DO NOT SPRAY, SPLASH, OR IMMERSE IN CLEANING SOLUTIONS.

The lenses and other internal parts cannot be accessed by the operator for cleaning.

The SightChek requires no user maintenance. It is recommended that you send in your Phoroptor Head to Reichert if interior lens cleaning is necessary.

To ensure that your Phoroptor Head remains clean, cover your Phoroptor Head with the dust cover when not in use. Consistent use of the dust cover will help keep dust and other contaminants off of the unit and from getting inside and possibly affecting operation.

Note: Make sure the power to the SightChek is OFF before you cover the instrument.

External Cleaning

CAUTION: DO NOT USE SOLVENTS OR STRONG CLEANING SOLUTIONS ON ANY PART OF THIS INSTRUMENT OR DAMAGE TO THE UNIT MAY OCCUR.

CAUTION: USE OF AMMONIABASED CLEANERS ON THE LIQUID CRYSTAL DISPLAY (LCD) OR ANY PLASTIC SURFACE MAY CAUSE DAMAGE TO THE INSTRUMENT.

Clean the external surfaces of this instrument using a clean, soft cloth moistened with a mild detergent solution (1 cc of liquid dish soap to one liter of clean water).

Controller Screen Cleaning

CAUTION: DO NOT USE ANY CHEMICAL SOLVENT, ACIDIC, OR ALKALI SOLUTIONS.

Clean the touch screen with a lint-free cloth, lightly dampened with a neutral detergent or isopropyl alcohol.

Face Shield Cleaning

For hygienic reasons, you can clean the Face Shield with a clean cloth moistened with a mild detergent solution (1 cc of liquid dish soap to one liter of clean, filtered water (filtered below 5 microns)).

Note: You can use a 70% isopropyl alcohol wipe. Be sure the Face Shield is completely dry before positioning another patient.

Forehead Rest Cleaning

You can clean the Forehead Rest with a clean cloth moistened with a mild detergent solution (1 cc of liquid dish soap to one liter of clean, filtered water (filtered below 5 microns)).

Note: If the Forehead Rest must be sanitized, you can use a 70% isopropyl alcohol wipe. Be sure the Forehead Rest is completely dry before positioning another patient.

Cleaning and Maintenance (continued)

Fuse Replacement

1. Unplug the Relay Box power cord.
2. Squeeze in the tabs on the Fuse Holder and pull the Fuse Holder out. Refer to Figure MM-01.

Note: Tweezers or a similar tool can be used to remove the fuse holder.

3. Remove the fuses that require replacement, and install new fuses. Refer to Figure MM-02.

Note: Refer to the Specifications section of this manual for fuse specifications.

4. Install the Fuse Holder into the Relay Box Assembly until it snaps into place.



Figure MM-01 Fuse Holder Tabs

Battery Replacement

Time and Date are maintained in memory by a long-life battery (CR 2032 Lithium Coin Cell Battery), in the Controller. This long-life battery lasts many years. If the Time and Date do not work, contact Reichert (Please refer to the Troubleshooting section of this manual).

Shipping the Phoroceptor Head

If the Phoroceptor Head needs to be shipped for any reason, follow the directions below to ensure that the head remains safe during shipping.

1. Remove the near point chart, the near point holder and the near point chart bar from the Phoroceptor Head.
2. Adjust the headrest so it is as close to the Phoroceptor Head as possible.
3. Press and hold the **CLEAR**, ◀, and ▶ buttons on the controller at the same time. The Phoroceptor Head will move into position so it is ready to be boxed for transit.
4. When the Phoroceptor Head has stopped moving, it is ready to pack up.



Figure MM-02 Fuse Holder Removed

Troubleshooting

Troubleshooting

Only those errors indicated on the display are directly important to the user and are listed below. In case of support requests, please refer to the Error Log File (OPTIONS - Service - Show Error Log File) where you will find a detailed listing of all errors, warnings, and status messages.

Error Source	Probable Cause	Solution
Paper empty	<ul style="list-style-type: none"> Paper has run out 	<ul style="list-style-type: none"> Refill Paper with PN 16290-006
Printer overheated	<ul style="list-style-type: none"> Printer is too hot and needs to cool down 	<ul style="list-style-type: none"> Allow printer to cool down before trying to print again
Printer cover opened	<ul style="list-style-type: none"> Printer door is open 	<ul style="list-style-type: none"> Close printer door
Printer cutter error	<ul style="list-style-type: none"> Printer cutter mechanism broken 	<ul style="list-style-type: none"> Printer may need repair or replacement Contact Reichert for service
PD error	<ul style="list-style-type: none"> Error with PD mechanism 	<ul style="list-style-type: none"> Restart system. Contact Reichert for service
WD error	<ul style="list-style-type: none"> Error with convergence 	<ul style="list-style-type: none"> Raise and re-lower the Reading Rod Restart system Contact Reichert for service
Right disk1 error Right disk2 error Right disk3 error Right disk4 error Right disk5 error Right disk6 error Right lens4-5 error Right lens6 in error Right lens6 out error Left disk1 error Left disk2 error Left disk3 error Left disk4 error Left disk5 error Left disk6 error Left lens4-5 error Left lens6 in error Left lens6 out error	<ul style="list-style-type: none"> Error in Phoroceptor head lens disk dials 	<ul style="list-style-type: none"> Restart system Contact Reichert for service.
PD LED error	<ul style="list-style-type: none"> Error with PD LED illumination 	<ul style="list-style-type: none"> Restart system Contact Reichert for service
Busy error Right communication error Left communication error	<ul style="list-style-type: none"> Communication error 	<ul style="list-style-type: none"> Restart system Contact Reichert for service
Invalid combination error	<ul style="list-style-type: none"> Selected test, setting, or input lenses not available for particular testing combination 	<ul style="list-style-type: none"> Chose a different lens or test Continue to the next refraction step

If failures cannot be remedied by one of these measures, please contact Reichert Technical Support as indicated on the back of this manual.

Specifications

Specifications

REF 16290

Physical Dimensions

Phoropter Head (REF 16291)

Spherical Effects	+27.25 to -28.75 D
Steps	0.12D, 0.25D, 0.5D and 1.0 D
Cylinder Power	-6.0 to +6.0 D
Steps	0.25D, .50D and 1.0 D
Axis Adjustment.....	0° to 180°
Steps	1°, 5° and 10°
Cross Cylinder Test	±0.25 D, ±0.5 D and Split
Prismatic Effects.....	+ 20Δ per eye
Steps	0.1Δ, 0.5Δ and 1.0Δ per eye
Corneal Vertex Distance.....	12, 13.75, 15 and 18 mm
Pupil Distance	48 to 80 mm
Steps	0.5 mm, 1 mm binocular
Convergence	cm (30, 40, 50, 60, or 70)
	inch (12, 16, 20, 24, or 28)
	Diopter (3.3, 2.5, 2.0, 1.7, or 1.4)
W x H x D	38.5-41.3 x 31.6 x 11.4 cm (15.1-16.2 x 12.4 x 4.5 in)
Weight	5.0 kg (11.0 lb)

Controller With Display (REF 16292)

W x H x D	27.2 x 16.5-20.4 x 29.3 cm (10.7 x 6.5-8.0 x 11.5 in.)
Weight	2.6 kg (5.7 lb)

Relay Box Assembly (REF 16293)

Input Voltage	100 - 240V~
Frequency	50 - 60 Hz
Current (max.)	90 VA
Fuses.....	T2AL 250V
Ports	Inst 1, Inst 2, EMR, Proj, Transfer, Head, Controller
W x H x D	32.6 x 10.3 x 11.9 cm (12.8 x 4.0 x 4.7 in.)
Weight	2.4 kg (5.3 lb)

SightChek Assembly in Package (REF 16290)

W x H x D	46.0 x 47.2 x 64.0 cm (18.1 x 18.6 x 25.2 in)
Weight	16.0 kg (35.3 lb)

Specifications (continued)

Environmental:

The environmental conditions are as follows:

Operating:

Temperature: 10° to 35° C (50° to 95° F)

Relative Air Humidity: 30 to 90%

Air Pressure: 80 kPa to 106 kPa

Transportation and Storage:

Temperature: -10° to 55° C (14° to 131° F)

Relative Air Humidity: 10 to 95%

Air Pressure: 80 kPa to 106 kPa

Operation permitted in explosion proof atmosphere only.

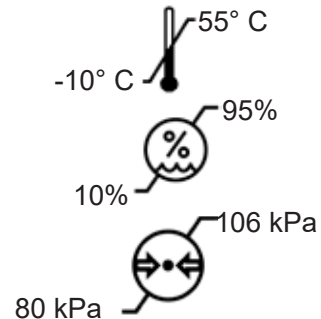

Disposal

Dispose of the SightChek in accordance with local regulations. The SightChek contains no hazardous materials.

Software Revision

You can obtain the software version by opening up the Service Menu in the Controller, or by contacting Reichert with the Relay Box Assembly serial number.

Classifications

Compliance

The SightChek complies with:

ANSI/AAMI ES60601-1:2005 + A1:2012
CAN/CSA C22.2 No.60601-1:2014
CENELEC EN 60601-1:2006
CENELEC EN 60601-1-2:2007
IEC 60601-1:2005 + CORR. 1:2006 + CORR. 2:2007 + A1:2012
IEC 60601-1-6:2010 + A1:2013
IEC 62366:2007 + A1:2014
ISO 15004-1:2009

Device Classification

Electrical Protection:	Class I
Ingress Protection Rating:	IPX0
Instrument Type (60601-1):	Type B
Operating Mode (60601-1):	Continuous
US FDA, Class I, 21 CFR 886.1770 and 886.1665	
EU Medical Device Directive:	Class I, Rule 12
CAN CMDR:	Class I, Rule 12

Guidance Tables

Table 201 – Guidance and Manufacturer’s Declaration Electromagnetic Emissions All Equipment and Systems		
Guidance and Manufacturer’s Declaration – Electromagnetic Emissions		
The SightChek is intended for use in the electromagnetic environment specified below. The customer or user of the SightChek should ensure that it is used in such an environment.		
Emissions Test	Compliance	Electromagnetic Environment - Guidance -
RF Emissions CISPR 11	Group 1 Class A	The SightChek uses RF energy only for its internal function. Therefore, its RF emissions are very low and are not likely to cause any interference in nearby electronic equipment.
Harmonics IEC 61000-3-2	Class A	The SightChek is suitable for use in all establishments, including domestic establishments and those directly connected to the public low-voltage power supply network that supplies building for domestic power.
Flicker IEC 61000-3-3	Complies	

Note: The emissions characteristics of this equipment make it suitable for use in industrial areas and hospitals (CISPR 11 class A). If it is used in a residential environment (for which CISPR 11 class B is normally required) this equipment might not offer adequate protection to radio-frequency communication services. The user might need to take mitigation measures, such as relocating or re-orienting the equipment.

Bluetooth RF Transmitter Characteristics - Relay Box Assembly

- Contains FCC ID: QOQWT11I or QOQWT11UA
- Contains IC: 5123A - BGTWT11I or 5123A - BGTWT11UA
- Frequency 2400.0 - 2483.5 MHz, Spread Spectrum, 0.02 Watts

Bluetooth Adapter (Dongle) Characteristics

- Contains ICC ID: S7AIW02
- Contains IC: 8154A - 1W02
- Frequency 2400.0 - 2483.5 MHz, Spread Spectrum, 0.0264 Watts

FCC / IC Statements

This device complies with Part 15 of the FCC Rules. Operation is subject to the following two conditions:

1. This device may not cause harmful interference, and
2. This device must accept any interference received, including interference that may cause undesired operation.

This equipment complies with FCC radiation exposure limits set forth for an uncontrolled environment. End users must follow the specific operating instructions for satisfying RF exposure compliance. This transmitter must not be co-located or operating in conjunction with any other antenna or transmitter, except in accordance with FCC test procedures. This transmitter is considered as mobile device.

This device complies with Industry Canada licence-exempt RSS standard(s). Operation is subject to the following two conditions: (1) this device may not cause interference, and (2) this device must accept any interference, including interference that may cause undesired operation of the device.

<p align="center">Table 202 – Guidance and Manufacturer’s Declaration Electromagnetic Immunity All Equipment and Systems</p>			
<p align="center">Guidance and Manufacturer’s Declaration – Electromagnetic Immunity</p>			
<p>The SightChek is suitable for use in electromagnetic environment specified below. The customer or user of the SightChek should ensure that it is used in such an environment.</p>			
<p>Immunity Test</p>	<p>IEC 60601 Test Level</p>	<p>Compliance Level</p>	<p>Electromagnetic Environment - Guidance</p>
<p>ESD IEC 61000-4-2</p>	<p>±2.0, ±4.0, ±6.0kV Contact ±2.0, ±4.0, ±8kV Air</p>	<p>±2.0, ±4.0, ±6.0kV Contact ±2.0, ±4.0, ±8kV Air</p>	<p>Floors should be wood, concrete, or ceramic tile. If floors are synthetic, the R/H should be at least 30%.</p>
<p>EFT IEC 61000-4-4</p>	<p>±2kV Mains ±1kV I/Os</p>	<p>±2kV Mains ±1kV I/Os</p>	<p>Mains power quality should be that of a typical residential, commercial, or hospital environment.</p>
<p>Surge IEC 61000-4-5</p>	<p>±0.5, ±1.0kV Differential ±0.5, ±1.0, ±2.0kV Common</p>	<p>±0.5, ±1.0kV Differential ±0.5, ±1.0, ±2.0kV Common</p>	<p>Mains power quality should be that of a typical residential, commercial, or hospital environment.</p>
<p>Voltage Dips/Dropout IEC 61000-4-11</p>	<p>>95% Dip for 0.5 Cycle 60% Dip for 5 Cycles 30% Dip for 25 Cycles >95% Dip for 5 Seconds</p>	<p>>95% Dip for 0.5 Cycle 60% Dip for 5 Cycles 30% Dip for 25 Cycles >95% Dip for 5 Seconds</p>	<p>Mains power quality should be that of a typical residential, commercial, or hospital environment. If the user of the SightChek requires continued operation during power mains interruptions, it is recommended that the SightChek be powered from an uninterruptible power supply or battery.</p>
<p>Power Frequency 50/60Hz Magnetic Field IEC 61000-4-8</p>	<p>3A/m</p>	<p>3A/m</p>	<p>Power frequency magnetic fields should be that of a typical residential, commercial, or hospital environment.</p>

<p align="center">Table 204 – Guidance and Manufacturer’s Declaration Electromagnetic Immunity Equipment and Systems that are NOT Life-supporting</p>			
<p align="center">Guidance and Manufacturer’s Declaration – Electromagnetic Immunity</p>			
<p>The SightChek is intended for use in the electromagnetic environment specified below. The customer or user of the SightChek should ensure that it is used in such an environment.</p>			
<p align="center">Immunity Test</p>	<p align="center">IEC 60601 Test Level</p>	<p align="center">Compliance Level</p>	<p align="center">Electromagnetic Environment - Guidance</p>
<p>Conducted RF IEC 61000-4-6</p>	<p>3 Vrms 150 kHz to 80 MHz</p>	<p>(V1)=3Vrms</p>	<p>Portable and mobile RF communications equipment should be no closer to any part of the SightChek, including cables, than the recommended separation distance calculated from the equation applicable to the frequency of the transmitter.</p> <p>Recommended Separation Distance:</p> <p>$d=(3.5/V1)(\text{Sqrt } P)$</p> <p>$d=(3.5/V1)(\text{Sqrt } P)$ 80 to 800 MHz</p> <p>$d=(7/E1)(\text{Sqrt } P)$ 800 MHz to 2.5 GHz</p> <p>Where P is the max output power rating of the transmitter in watts (W) according to the transmitter manufacturer and d is the recommended separation distance in meters (m).</p> <p>Field strengths from fixed transmitters, as determined by an electromagnetic site survey, should be less than the compliance levels in each frequency range.</p> <p>Interference may occur in the vicinity of equipment containing a transmitter.</p> 
<p>Radiated RF IEC 61000-4-3</p>	<p>80 MHz to 2.5 GHz @ 3V/m</p>	<p>(E1)=3V/m</p>	
<p>Note 1: At 80 MHz and 800 MHz, the higher frequency range applies.</p> <p>Note 2: These guidelines may not apply in all situations. Electromagnetic propagation is affected by absorption and reflection from structures, objects, and people.</p> <p>* Field strengths from fixed transmitters, such as base stations for radio (cellular/cordless) telephones and land mobile radios, amateur radio, AM and FM radio broadcast and TV broadcast cannot be predicted theoretically with accuracy. To assess the electromagnetic environment due to fixed RF transmitters, an electromagnetic site survey should be considered. The measured field strength in the location in which the ME Equipment or ME System should be observed to verify normal operation. If abnormal performance is observed, additional measures might be necessary, such as re-orienting or relocating the ME Equipment or ME System.</p> <p>* Over the frequency range 150 kHz to 80 MHz, field strengths should be less than [V1] V/m.</p>			

Table 206 – Recommended Separation Distances between Portable and Mobile RF Communications Equipment and the SightChek for ME Equipment and ME Systems that are NOT Life-supporting. Guidance and Manufacturer’s Declaration - Electromagnetic Immunity			
Recommended Separation Distances for between Portable and Mobile RF Communications Equipment and the SightChek			
The SightChek is intended for use in the electromagnetic environment in which radiated RF disturbances are controlled. The customer or user of the SightChek can help prevent electromagnetic interference by maintaining a minimum distance between portable and mobile RF Communications Equipment and the SightChek as recommended below, according to the maximum output power of the communications equipment.			
Max Output Power of Transmitter (W)	Separation (m) 150 kHz to 80 MHz $d=(3.5/\sqrt{P})(\sqrt{P})$	Separation (m) 80 to 800 MHz $d=(3.5/\sqrt{P})(\sqrt{P})$	Separation (m) 800 MHz to 2.5 GHz $d=(7/\sqrt{P})(\sqrt{P})$
0.01	0.1166	0.1166	0.2333
0.1	0.3689	0.3689	0.7378
1	1.1666	1.1666	2.3333
10	3.6893	3.6893	7.3786
100	11.6666	11.6666	23.3333
For transmitters rated at a maximum output power not listed above, the recommended separation distance (d) in meters (m) can be estimated using the equation applicable to the frequency of the transmitter, where P is the maximum output power rating of the transmitter in watts (w) according to the transmitter manufacturer. Note 1: At 80 MHz and 800 MHz, the separation distance for the higher frequency range applies. Note 2: These guidelines may not apply in all situations. Electromagnetic propagation is affected by absorption and reflection from structures, objects, and people.			

Appendix A

Instrument Cables and Bluetooth Kits

WARNING: ANY NON-MEDICAL ELECTRICAL EQUIPMENT USED WITH THE SIGHTCHEK MUST BE COMPLIANT WITH APPLICABLE IEC OR ISO SAFETY STANDARDS.

Instrument	Kit REF	Description
Wireless Connection to ClearChart 4 Wireless Connection to ClearChart 4X Wireless Connection to ClearChart 4P Wireless Connection to AcuityChek	13778	Wireless Dongle Kit
	13779	USB Bluetooth Adaptor
Wireless Connection to ClearChart 2	16251	Wireless Dongle Kit
Wireless Connection to ClearChart 3P	16250	Wireless Dongle Kit
Wireless Connection to LensChek Plus Wireless Connection to LensChek Pro	15171	Wireless Dongle Kit
Wireless Connection to AL200	16250	Wireless Dongle Kit
Wireless Connection to AL500	16255	Wireless Dongle Kit
Wireless Connection to AL700	16253	Wireless Dongle Kit
Wireless Connection to OptoChek Plus	15171	Wireless Dongle Kit
Wireless Connection to RK600	16254	Wireless Dongle Kit
Wireless Connection to RK700	16253	Wireless Dongle Kit
Wireless Connection Computer	16255	Wireless Dongle Kit
Single Bluetooth Dongle with null modem pairing cable	16233	Wireless Dongle Kit

Lensometers	Cable REF	Length	Description
AL200	559-473	26 ft. / 8m	M/F Null Modem
	16200-440	35 ft / 11m	M/F Null Modem
AL500	559-263	49 ft. / 15m	F/F Null Modem
AL700	559-262	25 ft. / 7.6 m	M/F Straight Pass Cable
LensChek Plus and Pro	559-262	25 ft. / 7.6 m	M/F Straight Pass Cable

Acuity Systems & Computers	Cable REF	Length	Description
ClearChart 2 ClearChart 3P ClearChart 4 ClearChart 4X ClearChart 4P AcuityChek	16200-440	35 ft. / 11m	M/F Null Modem
	559-473	26 ft. / 8m	M/F Null Modem
Computer	559-261	7.6m / 25 ft.	DB9 F/F Null Modem
Serial to USB Converter	13207112	N/A	USB DB9 M

Auto Refractors/Keratometers	Cable REF	Length	Description
RK600	559-461	26 ft. / 8m	DB9 F / DB25 M Null Modem
RK700	559-262	25 ft. / 7.6m	M/F Straight Pass Cable
OptoChek Plus	559-262	25 ft. / 7.6m	M/F Straight Pass Cable

Warranty

Warranty and Limitation of Liability

This product is warranted by Reichert Technologies (“Reichert”) against defective material and workmanship under normal use for a period of one year from the date of invoice to the original purchaser. (An authorized dealer shall not be considered an original purchaser.) Under this warranty, Reichert’s sole obligation is to repair or replace the defective part or product at Reichert’s discretion.

This warranty applies to new products and does not apply to a product that has been tampered with, altered in any way, misused, damaged by accident or negligence, or that has the serial number removed, altered or effaced. Nor shall this warranty be extended to a product installed or operated in a manner not in accordance with applicable Reichert instruction manual, nor to a product that has been sold, serviced, installed or repaired other than by a Reichert factory, Technical Service Center, or authorized Reichert Technologies Dealer.

Lamps, bulbs, charts, cards and other expendable items are not covered by this warranty.

All claims under this warranty must be in writing directed to the Reichert factory, Technical Service Center, or authorized instrument dealer making the original sale and must be accompanied by a copy of the purchaser’s invoice.

This warranty is in lieu of all other warranties implied or expressed. All implied warranties of merchantability or fitness for a particular use are hereby disclaimed. No representative or other person is authorized to make any other obligations for Reichert. Reichert shall not be liable for any special, incidental, or consequent damages for any negligence, breach of warranty, strict liability or any other damages resulting from or relating to design, manufacture, sale, use or handling of product.

PATENT WARRANTY

If notified promptly in writing of any action brought against the purchaser based on a claim that the instrument infringes a U.S. patent, Reichert will defend such action at its expense and will pay costs and damages awarded any such action, provided that Reichert shall have sole control of the defense of any such action with information and assistance (at Reichert’s expense) for such defense, and of all negotiation for the settlement and compromise thereof.

PRODUCT CHANGES

Reichert reserves the right to make changes in design or to make additions or improvements in its products without obligation to add such to products previously manufactured.

CLAIMS FOR SHORTAGES

We use extreme care in selection, checking, rechecking and packing to eliminate the possibility of error. If any shipping errors are discovered:

1. Carefully go through the packing materials to be sure nothing was inadvertently overlooked when the unit was packed.
2. Call the dealer you purchased the product from and report the shortage. The materials are packed at the factory and none should be missing if the box has never been opened.
3. Claims should be filed within 30 days.

CLAIMS FOR DAMAGES IN TRANSIT

Our shipping responsibility ceases with the safe delivery in good condition to the transportation company. Claims for loss or damage in transit should be made promptly and directly to the transportation company.

If, upon delivery, the outside of the packing case shows evidence of rough handling or damage, the transportation company’s agent should be requested to make a “Received in Bad Order” notation on the delivery receipt. If within 48 hours of delivery concealed damage is noted upon unpacking the shipment and no exterior evidence of rough handling is apparent, the transportation company should be requested to make out a “Bad Order” report. This procedure is necessary in order for the dealer to maintain the right of recovery from the carrier.

Notes

Notes

Notes



Manufacturer
Reichert, Inc.
3362 Walden Ave
Suite 100
Depew, NY 14043
USA

Toll Free 888-849-8955
Phone: 716-686-4500
Fax: 716-686-4555
Email: reichert.information@ametek.com
www.reichert.com

Authorized European Representative
Emergo Europe
Prinsessegracht 20
2514 AP The Hague
The Netherlands
Tel: (31) (0) 70 345-8570
Fax: (31) (0) 70 346-7299
Email: EmergoVigilance@ul.com

ISO 13485 Certified



16290-101 Rev. G

2020-02-20

